



UTAH DEPARTMENT of
ENVIRONMENTAL QUALITY
**WATER
QUALITY**

A Guide to Low Impact Development within Utah

Prepared for:

Utah Department of Environmental Quality
Division of Water Quality

195 North 1950 West
Salt Lake City, UT 84116

December 2018

Prepared by:

Michael Baker International
7090 South Union Park Ave, Suite 500
Salt Lake City, UT 84047



Environmental Planning Group, LLC
208 E 800 S
Salt Lake City, UT 84111



Table of Contents

Introduction.....	1
Purpose.....	1
Low Impact Development	1
Projects Covered by the Manual	2
Storm Water Integration.....	3
Long-Term Storm Water Management at the Jurisdictional Level.....	3
Impaired Waters	3
Ordinances	3
Ordinances within Utah	4
Retrofitting Programs.....	7
Curb Cuts	8
Dual-Purpose Basins.....	9
Trash Capture Devices	9
Alternative Compliance and Credit Systems	9
Alternative Compliance Options	9
Credit Systems and Alternative Compliance Programs	10
Minnesota Pollution Control Agency	10
San Diego County	10
Los Angeles County	11
Storm Water at the Project Level.....	12
Site Considerations	12
Soils.....	12
Groundwater	13
Existing drainage patterns.....	13
Existing pervious areas and vegetation	13
Site Design Practices.....	13
Reduction of Impervious Surfaces	13
Disconnected Impervious Areas.....	14
Curb Cuts	14
Documentation	15
The 90 th Percentile Volume	16
LID Impact on Hydrology	16
Developing the 90 th Percentile Volume	16
Step 1: 90 th Percentile Depth.....	17
Step 2: Imperviousness	17
Step 3: Volumetric Runoff Coefficient.....	17
Step 4: 90 th Percentile Volume	19
LID BMPs.....	21

Introduction	21
LID BMP Fact Sheets.....	21
Preface to Fact Sheets.....	22
Pollutant Removal Effectiveness	22
Primary Functions	22
Design Criteria	22
Calculation Methods.....	22
Sample Calculations	25
Evaluating BMP Effectiveness	25
Technical Infeasibilities.....	27
Water Quality Concerns	27
Designer Checklist	28
Vegetation	28
Installation	28
Installation Costs	28
Maintenance.....	28
Maintenance Activities	29
Maintenance Costs.....	29
Figures	30
Treatment Trains.....	30
Proprietary Devices	30
LID BMP Selection	31
BMPs Categorized by 303(d)/TMDL.....	31
BMPs Categorized by Land Use	32
BMP Selection Flow Charts.....	33
Vegetation Selection	37
Benefits of Using Vegetation in BMPs.....	37
Vegetation Considerations	38
Vegetation Guidance by BMP Type	40
Steps to Selecting Vegetation for BMPs.....	42
Land Use Examples	43
Local Case Studies	49
Preface to Case Studies.....	49
Additional Local LID Implementation	54
Daybreak, South Jordan	54
Utah State University Research Sites	54
Green Meadows, Logan	55
Northern Utah Runoff Coefficients.....	56
Appendix A 90 th Percentile Storm Depths	A-1
Appendix B Storm Water Quality Report Template.....	B-1
Appendix C LID BMP Fact Sheets.....	C-1

Rain Garden	C-2
Bioretention Cell.....	C-9
Bioswale	C-16
Vegetated Strip	C-23
Tree Box Filter	C-28
Green Roof	C-31
Pervious Surfaces.....	C-36
Infiltration Basin	C-41
Infiltration Trench.....	C-47
Dry Well	C-53
Underground Infiltration Galleries	C-58
Harvest and Reuse.....	C-62
Appendix D Utah Plant Hardiness Zones	D-1
Appendix E Utah Plant Selection Matrix by Climate Zone and BMP.....	E-1
Appendix F References	F-1

List of Tables

Table 1: Example parking lot runoff gap analysis results.	4
Table 2: LID ordinances within Utah.....	5
Table 3: Nationwide storm water programs using credit systems.	11
Table 4: LID project team.	12
Table 5: Runoff coefficient equations based on the NRCS Soil Group.....	19
Table 6: BMP types rated for the removal of pollutants that are either 303(d) listed or have approved TMDLs within Utah.	32
Table 7: Expected pollutants by common land uses.	33
Table 8: LID BMP characteristics designed for the Sandy City Public Works facility.	52
Table 9: Summary of monitored constituents at five sites.....	55

List of Figures

- Figure 1: Impervious parking lot with no pervious areas or storm water quality features2
- Figure 2: Potential curb cut location that could be retrofitted into a swale.....7
- Figure 3: Retrofitted island curb within parking lot7
- Figure 4: Multi-stage overflow outlet with trash screen9
- Figure 5: End-of-pipe trash netting.....9
- Figure 6: LID BMPs shown in site plans 12
- Figure 7: Downspout disconnected from parking lot..... 14
- Figure 8: Curb cuts to a rock lined swale. 14
- Figure 9: Typical hydrologic impact of development on-site hydrology..... 16
- Figure 10: General post development hydrograph with LID. 16
- Figure 11: Standing water after a rain event at a bioretention BMP. 29
- Figure 12: A vegetated swale that will provide pretreatment for a dry well..... 30
- Figure 13: Proprietary tree box filter 30
- Figure 14: Proposed residential development. 43
- Figure 15: LID approach to residential development. 44
- Figure 16: Proposed commercial development.45
- Figure 17: LID approach to commercial development. 46
- Figure 18: Proposed industrial development.....47
- Figure 19: LID approach to industrial development. 48
- Figure 20: Bioretention area at Mountview Park. 50
- Figure 21: Proposed rain garden location. 51
- Figure 22: Construction progress of permaculture garden.....53

Introduction

Purpose

This manual is to be used as a reference and guide for incorporating low impact development (LID) storm water approaches into new development and redevelopment projects. It helps planners and designers in selecting appropriate practices to incorporate in their site design as well as municipal separate storm sewer system (MS4) program managers in evaluating LID practices and determining what is most appropriate for their storm water programs. The information contained in this guidance complies with the goals of the federal Clean Water Act (CWA) “to reduce the discharge of pollutants to the maximum extent practicable.”

This manual provides background and technical information on LID best management practices (BMPs), maintenance practices, selection of appropriate plant materials, methods to retain the volume generated from the 90th percentile storm event, and other relevant information needed to assist decision makers, planners, designers, and reviewers in making the best possible decisions for their storm water programs and developments while complying with Utah’s Division of Water Quality (DWQ) storm water permit requirements.

Users of this manual are encouraged to seek out innovative and effective methods in addition to those discussed here to accommodate site-specific conditions and to achieve the key principles of LID and meet permit requirements. A wide array of LID approaches is presented; however, as with any environmental discipline for any development, site-specific decisions from qualified personnel will always be required. While the LID BMPs presented are widely used, local climate, soil conditions, vegetation, and other factors must be considered to determine what will work best within the project location.

Low Impact Development

LID refers to engineered systems, either structural or natural, that use or mimic natural processes to promote infiltration, evapotranspiration, and/or reuse of storm water as close to its source as possible to protect water quality and aquatic habitat. LID practices at the regional and site-specific level preserve, restore, and create green space using soils, vegetation, and rainwater harvesting techniques. These systems and practices are referred to as BMPs.

Green infrastructure (GI) includes LID practices but is a broader practice that also includes ecological services and approaches such as “filtering air pollutants, reducing energy demands, mitigating urban heat islands, sequestering and storing carbon, enhancing aesthetics and property values, and preserving and creating natural habitat functions.” (United States Environmental Protection Agency, 2012)

Urban development has historically resulted in increased impervious surfaces, vehicle use, and other human activities that introduce pollutants and create adverse hydrologic conditions detrimental to water quality. In the past, the goal of traditional storm water management was to convey these flows offsite as directly as possible (*Figure 1*), giving little to no consideration to preserving open spaces or creating pervious areas where rainfall could be managed onsite. Flood control infrastructure such as storm drains have been used to convey runoff and discharge it to a receiving surface water. Polluted runoff degrades the quality of the receiving water, impacting aquatic life and dependent ecosystems. Incorporating LID practices reduces the impact of development on natural waterways and watersheds and provides practical as well as aesthetic benefits. Other benefits include reduced construction costs by conveying runoff through vegetated swales instead of through pipes. Pavers or other pervious surfaces can reduce the size of an onsite basin by retaining runoff within a subsurface storage layer and

Key LID Principles

- Mimic natural processes
- Promote infiltration, evapotranspiration, harvest/reuse
- Manage storm water close to source
- Site design planning at project conception

bioretention areas can provide retention and treatment to improve water quality before discharging. These types of designs also enhance the aesthetics of the development and are viewed favorably by the public.

LID practices are not limited to long-term post-construction controls. Site design practices such as preserving natural areas and reducing the size and connectivity of impervious surfaces are examples of LID practices at the site planning stage that will result in improved water quality. City leaders, engineers, developers, and other stakeholders are encouraged to incorporate LID practices into project planning to maximize the effectiveness of their LID strategy and minimize negative impacts on water quality.

Extensive research and educational materials have been developed to assist in the understanding and implementation of LID practices. See the US Environmental Protection Agency (EPA) website on LID for an overview of LID concepts:

<https://www.epa.gov/nps/urban-runoff-low-impact-development>.



Figure 1: Impervious parking lot with no pervious areas or storm water quality features

Projects Covered by the Manual

The guidance provided in this manual is intended for all projects where the long-term management of storm water is required. New development and redevelopment projects within a permitted MS4 that disturb one acre or more, including projects less than one acre that are part of a larger common plan of development or sale, have specific LID requirements that must be met as part of DWQ's storm water program. All projects are encouraged to consider LID practices including projects for permitted non-traditional MS4s such as universities, medical centers, and prisons.

Additional LID requirements will be coming into effect for permitted MS4s. These municipalities will need to develop an LID approach which includes on-site retention of the precipitation from the 90th percentile storm event for all new development and redevelopment projects that are greater than or equal to an acre or part of a common plan of development or sale. This is intended to greatly increase the use of LID practices within Utah and subsequently improve water quality from storm water discharges.

Storm Water Integration

Long-Term Storm Water Management at the Jurisdictional Level

Successful integration of LID features and green infrastructure requires that jurisdictions be able to provide technical and planning guidance to stakeholders. Storm water master plans and technical guidance documents will assist stakeholders in developing their planning approach and design process

Organizational structures vary widely but implementation of long-term storm water quality requirements typically fall within the duties of the public works, utilities, engineering, maintenance, and/or land development groups. It may become necessary to have staff dedicated to storm water management as the jurisdiction develops ordinances, land development standards, storm water master plans, and review processes.

Familiarity with permit requirements is imperative to succeed at implementation. Dedication to achieve and maintain compliance with permit requirements is necessary for a successful and functioning storm water management program. Restraints to success; such as competing interests, budgetary constraints, lack of inter-departmental communication, and lack of support within the jurisdiction, must be addressed or they will jeopardize implementation at the program level, the planning level, and ultimately at the project level.

Impaired Waters

Permittees should be aware of receiving waters within their jurisdiction that have been listed as having impairments on the State's 303(d) list and those that have been identified as requiring or have an approved Total Maximum Daily Load (TMDL). Project sites near these waters may have additional restrictions and require more attention. An interactive map identifying such waters can be found at the DWQ website:

<https://enviro.deq.utah.gov/>

Ordinances

Ordinances should be adopted or modified that promote or mandate LID principles and green infrastructure for development within the jurisdiction. Ordinances should be developed that:

- Promote and preserve open spaces
- Help meet density goals by specifying building footprint, height limits, and setbacks that allow for the proper placement of LID BMPs
- Include an LID analysis as part of the site plan review
- Allow for the use of pervious surfaces within parking lots within parking code
- Encourage clustering development to increase green space within developments
- Address any public safety concerns relating to LID practices
- Allow vegetation appropriate to the BMP being used (See [Vegetation Selection](#) for specific information relating to the goals and benefits of selecting appropriate vegetation)
- Address maintenance agreements that:
 - Determine final ownership of the BMP (if not the MS4)
 - Require a maintenance schedule, list of activities, and identify the responsible party
 - Allow the municipality to access BMPs for inspections and/or maintenance
 - Provide a method of resolution should violation of the maintenance agreement occur

Examples of ordinances related to storm water maintenance and maintenance agreements templates may be found at the following links:

- EPA – Urban Runoff: Model Ordinances for Stormwater Control: <https://www.epa.gov/nps/urban-runoff-model-ordinances-stormwater-control>
- Utah Storm Water Advisory Committee – Long-Term Stormwater Management Agreement: <https://uswac.files.wordpress.com/2018/09/uswac-long-term-stormwater-management-agreement-template.docx>

Creating zoning ordinances and providing incentives that promote LID will lay the groundwork for LID implementation. A gap analysis of existing codes will determine if existing codes are preventing LID principles from being implemented.

A gap analysis is a systematic approach to reviewing ordinances to determine how LID practices can be written into city codes. The results of the gap analysis will identify the objective, a reference to specific codes or standards, and give recommendations for how the code can be modified (*Table 1*).

Table 1: Example parking lot runoff gap analysis results.

Objective	Code	Summary of Impediment
Determine if rain gardens, bioretention cells, and other bioretention devices are permitted within parking areas.	<i>ORD 04-13.b</i> Vegetation within parking lots shall be within raised areas and protected by curbs.	The existing code does not permit storm water flows within parking lots to sheet flow into bioretention or vegetated areas.

An example of a gap analysis template for Small MS4s within California was based on a requirement for permittees to review local planning and permitting processes and identify gaps or impediments to effective implementation of post-construction requirements. Landscaping is directly identified as a priority in the permit. The gap analysis identifies five areas related to the conservation and creation of landscapes (AHBL, 2017):

1. Vegetation conservation
2. Open space management
3. Rooftop runoff
4. Open space/cluster development
5. Street and parking lot standards

The full gap analysis template can be found here:

https://www.casqa.org/sites/default/files/downloads/20171109_gap_analysis_user_guide.pdf.

Ordinances within Utah

A review of current ordinances within Utah reveals that some cities have created or modified codes to address LID (*Table 2*). Ordinances range from general descriptions of implementation to entire sections dedicated to storm water ordinances and design criteria. Examples of some of these are provided in the following table.

Table 2: LID ordinances within Utah

City	Category	Ordinance
Spanish Fork	Land Use	15.4.16.085.F. <u>Grades</u> “...The minimum grade allowed for any City street is zero-point forty-five (0.45) percent. The City Engineer or his/her designee may allow a minimum grade of zero-point thirty-five (0.35) percent if the roadway has incorporated Low Impact Development (LID) systems. The maximum grade allowed for any private driveway is 12%.”
Spanish Fork	Utilities	13.16.040.E. “All site designs shall implement LID principles as defined in this Chapter and in the BMP Manual. Runoff rates from one lot to another may not exceed pre-existing conditions as defined by the City, nor in such a manner that may unreasonably and unnecessarily cause more harm than formerly.”
Spanish Fork	Utilities	<p>13.16.080. Waivers “Every applicant shall provide for post construction stormwater management as required by this Chapter, unless a written request to waive this requirement is filed and approved. Requests to waive the stormwater management plan requirements shall be submitted to the City SWMP Administrator for approval.</p> <p>For post construction, minimum requirements for stormwater management may be waived in whole or in part upon written request of the applicant, provided that at least one of the following conditions applies:</p> <ol style="list-style-type: none"> 1. It can be demonstrated that the proposed development is not likely to impair attainment of the objectives of this Chapter. 2. Alternative minimum requirements for on-site management of stormwater discharges have been established in a stormwater management plan that has been approved by the City Engineer. 3. Provisions are made to manage stormwater by an off-site facility. The off-site facility must be in place and designed to provide the level of stormwater control that is equal to or greater than that which would be afforded by on-site practices. Further, the facility must be operated and maintained by an entity that is legally obligated to continue the operation and maintenance of the facility.

City	Category	Ordinance
Moab*	Zoning	<p>17.80.050.10. <i>“Parking lots shall incorporate methods for storm water management utilizing low impact development (LID) techniques including, but not limited to:</i></p> <ul style="list-style-type: none"> <i>a. End-of-island bioretention cell(s) with underdrain(s) and landscaping;</i> <i>b. Bioretention cells or biofiltration swales located around the parking perimeter;</i> <i>c. Breached curb drainage inlets (or curb cuts) in the end-of-island bioretention cells and bioretention strips to collect runoff; or</i> <i>d. Bioretention cells installed between lines of parking stalls to increase the total treatment surface area of these systems.”</i>
Salt Lake City	Public Services	<p>Chapter 17.75 through 17.91 address storm water quality ordinances.</p> <p>17.75.200.C. <i>“Purposes and Objectives: In view of the foregoing, the purposes and objectives of this chapter through chapter 17.91, inclusive, of this title are to:</i></p> <ol style="list-style-type: none"> <i>1. Provide for and maintain a stormwater sewer system for collecting and disposing of stormwater runoff;</i> <i>2. Establish the inspection, surveillance and monitoring procedures, and all related rules and regulations, necessary to regulate discharges into the stormwater sewer system, and to establish the legal authority to enforce compliance with such rules and regulations; and</i> <i>3. Provide fair, equitable and nondiscriminatory rates and charges which will generate sufficient revenues to construct, operate, improve, and maintain the stormwater sewer system at a level commensurate with stormwater sewer management needs. It shall be the policy of the city that present and future costs of operating the stormwater sewer system shall be fairly allocated among the various users of the stormwater sewer system through the establishment of rates and charges based upon such factors as the intensity of development of the parcel; the types of development on the parcel; the amount of impervious surface on the parcel; the cost of maintenance, operation, repair and improvements of the various parts of the system; the quantity and quality of the runoff generated; and other factors which present a reasonable basis for distinction, and which will allow for management of the stormwater sewer system in a manner that protects the public health, safety and welfare. (Ord. 53-07 § 5, 2007)”</i>

City	Category	Ordinance
Logan	Public Services	13.14.200.A. <i>“All site designs shall control the peak flow rates of storm water discharge associated with design storms specified in this chapter or in the BMP manual and reduce the generation of postconstruction storm water runoff volumes and water quality to preconstruction levels. These practices should seek to utilize pervious areas for storm water treatment and to infiltrate storm water runoff from driveways, sidewalks, rooftops, parking lots, and landscaped areas to the maximum extent practical to provide treatment for both water quality and quantity. Other low impact development (LID) methods are also encouraged.”</i>

*Not a permitted MS4

Retrofitting Programs

A retrofit program is the structured evaluation of existing development to identify possible improvements to infrastructure with the goal of creating and improving the design of storm water practices and improving water quality. A retrofit program may require dedicated funding for development and implementation. Note that permitted MS4s are required to develop a ranking of control measures to determine those best suited for retrofits. Retrofits can be completed on both public and private properties. Retrofits on private property require coordination and approval from the property owner and may require encouragement through financial incentives to be accepted.

Retrofit programs include activities such as adding curb cuts that allow runoff of impervious surfaces to enter vegetated areas. *Figure 2* shows an existing development that has a slightly depressed, curbed, vegetated area that is surrounded by impervious surfaces. If allowable after considering grading of the site, potential conflicts with the existing utilities, and the environmental sensitivity of receiving waters, a curb cut or multiple curb cuts at the upstream end of the swale to allow parking lot storm water runoff to be conveyed through it would be considered a retrofit. Project site parameters such as the contributing drainage area, imperviousness, 90th percentile volume, water quality flow, and the swale’s geometry should be analyzed to determine the impact of the retrofit. Additional analysis would be needed to determine the potential contributing drainage area if a curb cut were to be made at the upstream end. *Figure 3* shows the curb of a parking lot island that has been retrofitted to allow storm water runoff to be retained within the island.

A common need among all programs is prioritizing where retrofit efforts should be focused based on geography and environmental needs. The following factors identified in the Utah 2016 General Permit for Discharges from Small MS4s (UTRO90000) must be considered in prioritizing:



Figure 2: Potential curb cut location that could be retrofitted into a swale



Figure 3: Retrofitted island curb within parking lot

- Proximity to waterbody
- Status of waterbody to improve impaired waterbodies and protect unimpaired waterbodies
- Hydrologic condition of the receiving waterbody
- Proximity to sensitive ecosystem or protected area
- Any upcoming sites that could be further enhanced by retrofitting storm water controls

The general steps below can be used in the development of a retrofit program:

1. Identify local need and capacity for storm water retrofitting. Include an evaluation of watersheds in the MS4 that are 303(d) listed or have TMDLs associated with them.
2. Identify potential locations within the MS4 including publicly owned properties, right-of-way, easements, culverts, and existing detention practices that lack adequate storm water practices or are undergoing modifications in the near future.
3. Visit potential project locations to verify current conditions and identify potential retrofit BMP options.
4. Create an inventory of potential locations with site sketches, photos, and basic hydraulic calculations.
5. Based on the permittee's developed ranking of control measures, evaluate retrofit options for factors like performance, cost, community support, property ownership, and feasibility.
6. Model water quality benefits for chosen retrofitting option to determine most cost-effective approach. Online models are available that give users multiple options and associated costs.
 - a. Green Values Storm Water Management Calculator: <http://greenvalues.cnt.org/calculator/calculator.php>
 - b. EPA's National Stormwater Calculator: <https://www.epa.gov/water-research/national-stormwater-calculator>
7. Once the most cost-effective and environmentally beneficial option is determined and funds are obtained, move the project to the design and construction phase. Allow time for sites surveys, permitting, bidding, and specifications.

The LID BMPs described in this manual can be used to retrofit existing sites in addition to the control measures described below.

Curb Cuts

Identify areas where introducing a curb cut will result in flows being diverted from gutters into vegetated areas. A curb cut detailing a depression within the curb may be needed to ensure that flows do not bypass the curb cut. Regrading of the vegetated receiving area and inlet protection may be necessary on the downstream side of the cut.

Dual-Purpose Basins

Retrofitting the outlet structure of a flood control basin creates a dual-purpose basin that accommodates flood control flows and the 90th percentile volume (Figure 4). Determine the 90th percentile volume of the contributing drainage area and provide an outlet near the bottom of the structure that releases the 90th percentile volume within an acceptable drawdown time. Modification of the outlet structure can be as simple as adding orifices to a pipe riser or could require design of a new outlet structure.

Perform infiltration testing (or obtain from project plans) within the basin to determine the infiltration rate of the soils within the basin. If infiltration rates are appropriate for retention, the detention basin will also function as an infiltration basin.

Trash Capture Devices

Trash collection devices are installed as in-line systems or end-of-pipe systems to prevent large solids from entering a receiving water or basin. In-line systems require more design effort and expense for retrofitting but end-of-pipe systems such as that seen in Figure 5 are easier to install retroactively to a pipe end section depending on the end section configuration.

Linear radial devices are in-line or end-of-pipe trash collection devices that can be installed either within the pipe or at the end of a pipe prior to discharging to a basin or receiving water. The EPA provides additional information about the use of linear radial devices: <https://www.epa.gov/trash-free-waters/clean-water-act-and-trash-free-waters>.

Alternative Compliance and Credit Systems

Alternative Compliance Options

Municipalities may choose to adopt alternative options that provide water quality benefits either on-site or off-site. Off-site treatment is only considered when it is technically infeasible to retain the 90th percentile volume within the project limits as required for permitted MS4s. This is done within the project limits, within the watershed or subwatershed of the project, or on a regional level. If retention of the 90th percentile volume is technically infeasible for a project, possible alternative compliance measures include:

- Implementation of BMPs that provide water quality treatment such as bioswales, filter strips, etc.
- Proprietary water quality treatment devices.
- The creation of off-site retention areas within the original project's subwatershed that is sized for the volume unable to be captured.
- Establishment of a credit system that allows for the tracking of volume reduction and pollutant reduction throughout the municipality's jurisdiction.



Figure 4: Multi-stage overflow outlet with trash screen



Figure 5: End-of-pipe trash netting

Spanish Fork's Municipal Code (13.16.080) which is cited within the example ordinances ([Table 2](#)), allows requests to be submitted to waive post construction storm water requirements.

Credit Systems and Alternative Compliance Programs

In its simplest form, a credit system is a database of projects that documents project volume retention goals and the actual volume retained. This applies to pollutant reduction goals as well. Regional BMPs can be used within the credit system. Additional runoff at one project location can be retained to account for runoff that may have been technically infeasible to retain at other project locations.

A few examples of credit systems and other alternative compliance programs are briefly explained below. Links to additional credit systems in use throughout the country are found below the examples in [Table 3](#).

Minnesota Pollution Control Agency

The state of Minnesota credit system quantifies storm water runoff volume and pollutant reduction. Every cubic foot of the design storm that is captured is counted as a credit. Pollutant removal is counted as 1 credit based on the unit of measurement for the pollutant. For example, if a BMP removes 10 pounds of phosphorus per year, it is counted as 10 credits. Multiple credits can be claimed for each BMP depending on its function. A bioretention area that removes multiple pollutants can claim credit for the volume reduction and the reduction of any pollutants (Kieser & Associates, LLC, 2009).

Credits can be used towards the following:

- To meet a TMDL waste load allocation
- To meet the Minimal Impact Design Standards performance goal
- To provide incentive to site developers to encourage the preservation of natural areas
- To reduce costs associated with BMPs
- To supplement the Minnesota Pollution Control Agency Construction General Permit or be used for projects not covered under the CGP
- As part of the financial evaluation under a local storm water utility program

San Diego County

San Diego County implements an Alternative Compliance program that is implemented in areas that are unable to retain 100% of the required retention volume on-site. There may be several reasons why the volume cannot be handled on-site including poorly infiltrating soils, high groundwater, and concerns with pollutant mobilization. San Diego County has identified the following measures for alternative compliance (California Regional Water Quality Control Board San Diego Region, 2015):

- Stream or riparian area rehabilitation
- Retrofitting existing infrastructure for storm water retention or treatment
- Groundwater recharge projects
- Regional BMPs
- Water supply augmentation projects
- Floodplain preservation through land purchase

Los Angeles County

Los Angeles County also implements an Alternative Compliance program. Los Angeles County has identified the following measures for alternative compliance (California Regional Water Quality Control Board Los Angeles Region, 2016):

- On-site biofiltration
- Offsite infiltration
- Groundwater replenishment projects
- Offsite retrofitting projects
- Regional storm water mitigation programs

If using biofiltration, the county requires the project to treat 1.5 times the volume retention goal that cannot be retained on-site. Offsite infiltration requires a project to retain the portion of the project’s volume retention goal that is unable to be retained on-site as well as reduce pollutant loads from the runoff. Groundwater replenishment projects are required to intercept the volume retention goal not retained on-site through infiltration, bioretention, or groundwater replenishment BMPs. These projects are required to be located in the same sub-watershed as the development. For retrofitting projects, developers are required to retain the volume retention goal not retained on-site through BMP measures at a site with similar land uses. The regional storm water mitigation program option allows permittees to create a program for handling runoff on a regional or sub-regional scale.

Table 3: Nationwide storm water programs using credit systems.

State or Local Storm Water Guidance Document	Web Link
Vermont Storm Water Management Manual	https://dec.vermont.gov/sites/dec/files/wsm/stormwater/docs/Permitinformation/2017%20VSMR_Rule_and_Design_Guidance_04172017.pdf
Minnesota Stormwater Manual	https://www.pca.state.mn.us/water/minnesotas-stormwater-manual
Philadelphia Storm Water Management Guidance Manual	https://www.pwdplanreview.org/manual-info/guidance-manual
New Jersey Storm Water Best Management Practices Manual	https://www.njstormwater.org/bmp_manual2.htm
Maryland Storm Water Design Manual	https://mde.maryland.gov/programs/Water/StormwaterManagementProgram/Pages/index.aspx
Georgia Storm Water Management Manual	https://atlantaregional.org/natural-resources/water/georgia-stormwater-management-manual/
Pennsylvania Storm Water Best Management Practices Manual	http://www.depgreenport.state.pa.us/elibrary/GetFolder?FolderID=4673
Ontario Storm Water Management Planning and Design Manual	https://www.ontario.ca/document/stormwater-management-planning-and-design-manual-o
Storm Water Management Manual for Western Washington	https://ecology.wa.gov/Regulations-Permits/Guidance-technical-assistance/stormwater-permittee-guidance-resources/stormwater-manuals

Source: Center for Watershed Protection

Storm Water at the Project Level

Incorporating LID principles at the planning stages of a development will increase the likelihood that they will be able to be integrated into the site (Figure 6). If LID is considered late in the design, it becomes more expensive to implement due to costs associated with redesign of the site layout, additional geotechnical studies, or coordination with community councils, watershed management groups, or other state or federal agencies. Integration of LID principles should be done by qualified engineers who understand the goals of the project, the requirements within the municipality's jurisdiction, and the design criteria for the BMPs.

Collaboration among a project's stakeholders for including LID principles should occur as part of the regular project development, as would be the case for other design elements like grading, utilities, and flood control. As the design progresses, project meetings should include discussion on the storm water elements of the project to ensure that water quality requirements are being met and that the LID approach is functional and compatible with the site's hydrologic and hydraulic design. Additional meetings and coordination to address design details and/or conflicts should be expected. A list of potential project team members who will be involved in the coordination and/or design of LID features is presented in Table 4.

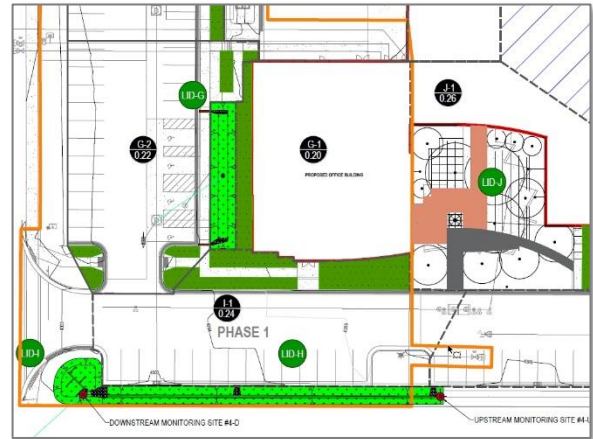

Figure 6: LID BMPs shown in site plans

Table 4: LID project team.

Jurisdiction/Permittee		Site Designer/Developer/Architect
MUNICIPALITY	NON-TRADITIONAL MS4s	Project Manager
Storm Water Coordinator	Storm Water Coordinator	Civil Engineers
Environmental Compliance	Environmental Compliance	Geotechnical Engineers
City Engineer	Facilities Director	Lead Architect
Public Works	Project Coordinator	Landscape Architects
Utilities	Utilities	Landscape Engineers
Planner	Planner	Environmental Engineers
Maintenance	Maintenance	
Landscaping	Landscaping	

Site Considerations

Gather subsurface, geotechnical, topographical, and any other technical information about the site to incorporate into the site design. Site conditions will dictate an appropriate LID approach by revealing opportunities and limitations.

Soils

Soil characteristics will determine if certain LID approaches are feasible. Soils that are classified as Hydrologic Soil Group 'A' are generally acceptable for bioretention and infiltration BMPs. 'B' soils may be marginal for

infiltration and bioretention. 'C' and 'D' soils generally have limited capacity for bioretention and infiltration. For a planning level analysis of the Hydrologic Soil Groups, the Web Soil Survey developed by the National Cooperative Soil Survey can be used: <https://websoilsurvey.sc.egov.usda.gov/App/WebSoilSurvey.aspx>. For design, geotechnical reports should determine if the existing soils are acceptable.

Groundwater

Infiltration BMPs should not be utilized within areas of shallow groundwater as it may lead to flooding of the BMP or introduction of pollutants into the groundwater. Measurements should be taken at each BMP location to determine the depth to the historical high groundwater level. The following groundwater resources are available for planning level decision making:

Hydrogeology of Recharge Areas and Water Quality of the Principal Aquifers along the Wasatch Front and Adjacent Areas, Utah – A snapshot of the overall hydrogeology within the Wasatch Front area of Utah.
<https://pubs.usgs.gov/wri/1993/4221/report.pdf>

Groundwater Conditions in Utah, Spring of 2017 – An annual report on groundwater conditions within Utah.
<https://ut.water.usgs.gov/publications/GW2017.pdf>

Utah Active Water Level Network, USGS – Active monitoring of groundwater wells throughout the state.
<https://groundwaterwatch.usgs.gov/StateMap.asp?sa=UT&sc=49>

Project sites with contaminated groundwater may not be appropriate for infiltration due to the potential for mobilizing the contamination into new areas. Coordinate with jurisdictions or watershed management groups to identify areas with contaminated groundwater to determine the level of concern it presents.

Existing drainage patterns

Drainage patterns will be readily evident for any redevelopment project either from visual observation or from plan sets. Determine the constraints introduced by the existing storm drain network such as pipe capacity and inlet and outlet elevations. For new development projects, determine the existing drainage patterns as determined by the site's topography. It is more likely that the site's pre-development hydrology can be mirrored if the design maintains the original drainage patterns and paths.

Existing pervious areas and vegetation

If existing pervious areas can support bioretention or already provide bioretention, maintain them or otherwise make them a part of the site design. Taking advantage of natural depressions or areas of vegetation is an ideal and cost-effective alternative to grading and design. Preserve existing trees and other vegetation on-site when possible.

Site Design Practices

Storm water treatment and retention is most effective when done close to its source. Site design practices accomplish this by taking advantage of approaches that are not necessarily quantifiable but are aimed at reducing the overall impact of the development.

Reduction of Impervious Surfaces

Reducing impervious surfaces, preserving pervious surfaces, or creating pervious surfaces provides multiple benefits to storm water quality. From a storm water quality standpoint, the potential for treatment is higher for runoff that lands on the pervious surface instead of on an impervious surface. Pervious surfaces with healthy soils will infiltrate more runoff from frequent storms. From a design standpoint, increasing the pervious area decreases the total runoff from the site. Pervious surfaces also provide the opportunity to add shade trees or other types of vegetation that will increase the aesthetic appeal of the site.

Disconnected Impervious Areas

The practice of connecting impervious areas to the storm drain network is ubiquitous as traditional designs encouraged the removal of runoff as quickly as possible. This practice leads to increased runoff volume from rain events and increased peak flows. Treatment of runoff is virtually nonexistent as it is conveyed from rooftop to sidewalk to parking lot to catch basin to receiving water, taking with it all the pollutants it encounters in its path. Disconnecting impervious areas by introducing pervious areas or rerouting flows from impervious surfaces (*Figure 7*) slows down flows and reduces the volume discharged to the downstream storm drain network or removes it entirely. Treatment is also provided through bioretention and biofiltration.



Figure 7: Downspout disconnected from parking lot

Curb Cuts

Curb cuts can be part of a site plan or be introduced as part of a retrofit program. Curb cuts are a simple way to convey flows from an impervious surface to a pervious surface (*Figure 8*). Roadways and parking lots are prime locations to investigate whether curb cuts can be used to divert flows from a traditional storm drain network to a pervious area or a bioswale, bioretention or infiltration area, or another type of BMP.



Figure 8: Curb cuts to a rock lined swale.

Additional site design practices

- Preserving natural areas
- Site reforestation
- Stream and shoreline buffers
- Open space design
- Disconnecting rooftop and impervious discharges and distributing runoff
- Soil compost amendments
- Grass channels
- Storm water landscaping
- Reducing impervious cover in site design
 - Narrower streets and sidewalks
 - Smaller cul-de-sacs
 - Shorter driveways
 - Smaller parking lots

Documentation

MS4s are required to review and document that a project's LID approach and design are consistent with the permittee's requirements and other project developers may wish to document design parameters. A template for documentation is provided in [Appendix B](#). The storm water quality report template provides jurisdictions a sample of project documentation that ensures consistent design and verifies compliance with LID considerations and retention requirements. The report template may be used during a project's design and review process and be required as part of a project's submittal documents to ensure that water quality requirements have been met. The review process may differ between municipalities, and the template can be altered as needed by the user. Sample text is highlighted.

The 90th Percentile Volume

LID Impact on Hydrology

Storm water programs have focused on the goal of mimicking predevelopment hydrologic conditions over the last several decades as municipal and department of transportation (DOT) storm water programs have increased their efforts to comply with the Federal Clean Water Act of 1972 and their associated MS4 permits. LID BMPs, green infrastructure practices, and retention of the 90th percentile volume are tools and requirements that are used to accomplish this goal.

More frequent peak flows, higher peak flows, and higher runoff volumes are well-documented hydrologic impacts of urbanization and development due to an increase in impervious surfaces (D.B. Booth, 1997; Konrad & Booth, 2002) (Figure 9).

Traditional approaches to storm water management that remove runoff from a site by quickly conveying flows to a storm drain network are also effective in protecting life and property and should be implemented in tandem with low impact design principles. Within Utah, discharges are typically limited to between 0.1 cfs and 0.2 cfs per acre.

An LID approach to site development produces a hydrologic condition that more closely mimics the pre-development hydrologic condition. Peak flows are reduced and are less frequent (Figure 10); runoff volume is also reduced (WEF Press, 2012).

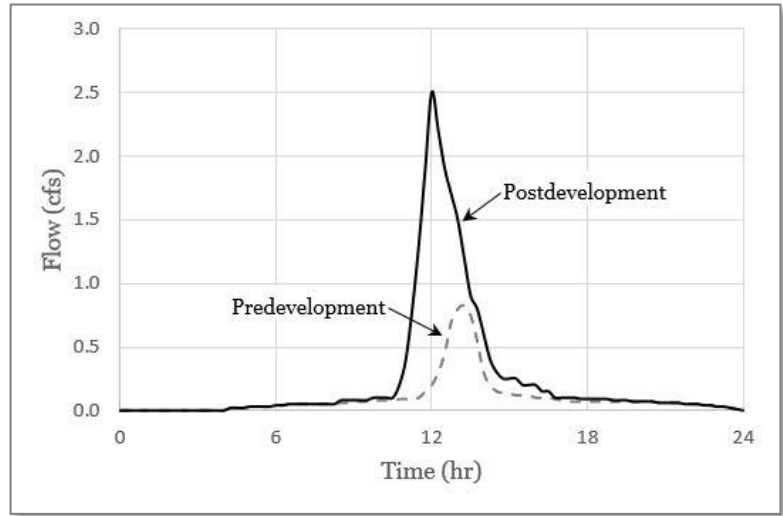

Figure 9: Typical hydrologic impact of development on-site hydrology.

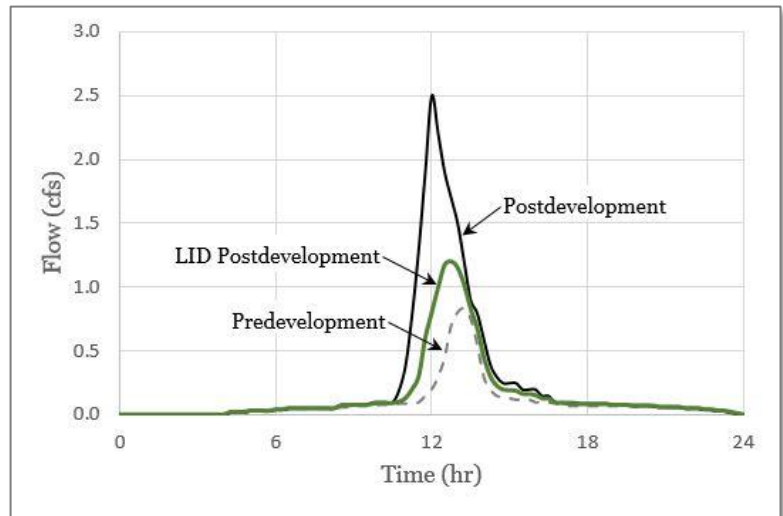

Figure 10: General post development hydrograph with LID.

Developing the 90th Percentile Volume

Project Volume Retention Goal, V_{goal} – The volume of runoff generated within the project’s limits of disturbance over a 24-hour period during the 90th percentile storm event.

Water Quality Volume, WQV – The volume of runoff generated within a BMP’s drainage area over a 24-hour period during the 90th percentile storm event.

The following steps may be used to determine the project volume retention goal and the water quality volume.

Step 1: 90th Percentile Depth

Determine the 90th percentile precipitation depth.

1. Obtain long-term daily rainfall data from the following sources:
 - a. National Oceanic and Atmospheric Administration (NOAA): <https://www.ncdc.noaa.gov/cdo-web/datatools/selectlocation>; or
 - b. Reliable historical local data; or
 - c. Any other reliable data source.
2. Sort data low to high.
3. Remove snowfall and small precipitation events (≤ 0.1 inch).
4. Use the Excel PERCENTILE function to calculate the 90th percentile rainfall depth.

A more in-depth discussion on determining the 90th percentile precipitation depth is found here: <https://deq.utah.gov/legacy/topics/fact-sheet/docs/handouts/2016/05may/calculation-90-percentile-storm-event.pdf>.

A reliable record of historical precipitation data should meet the following conditions:

1. Come from an active rain gage;
2. Have at least 30 years of data;
3. Have 90% data coverage for the period of record.

The 90th percentile depth for rain gages from NOAA that currently meet these criteria can be found in [Appendix A](#). MS4s may choose to calculate their depths from a different source. Planners and developers should verify with the MS4 before relying on these reference values.

Step 2: Imperviousness

To determine the project's volume retention goal, determine the imperviousness within the disturbance limits of the project. To determine the water quality volume of a BMP's drainage area, determine the imperviousness of the drainage area. The imperviousness of the BMP drainage area will include any off-site impervious areas that are part of the BMP's drainage area.

Project imperviousness = Post-development impervious area / Project's disturbance limits

BMP imperviousness = Post-development impervious area within BMP drainage area / BMP drainage area

Step 3: Volumetric Runoff Coefficient

Determine the volumetric runoff coefficient (R_V).

The volumetric runoff coefficient (also referred to as just the 'runoff coefficient') is a calculation of the percentage of rainfall that results in surface runoff. Runoff coefficients for small, frequent storms, such as for the 90th percentile, are not equivalent to runoff coefficients for large, less-frequent storms such as the 10-yr event and greater that are used with the Rational Method. The effects of infiltration, retention, and interception are increased for the smaller storm events compared to the larger events. Because of this, runoff coefficients for smaller storms are numerically smaller than for larger storms.

In 1983 data from over 50 sites nationwide was evaluated as part of the Nationwide Urban Runoff Program (NURP) (Driscoll, 1983). From these sites, mean and median R_V values were calculated and compared to the site's

imperviousness. This research led to the following conclusions that are also discussed by Schueler who did additional analysis of the NURP sites:

1. “Most of the variation in mean R_V among sites can be attributed to differences in the level of urbanization, and in particular, to the site imperviousness.”
2. “ R_V ’s were found to be relatively consistent at individual sites and were only weakly correlated with storm-related variables such as precipitation volume, intensity, and duration.”
3. “The runoff coefficient could serve as a reliable estimator of runoff volumes, given an initial estimate of rainfall volume.” (Schueler, Controlling Urban Runoff: A Practical Manual for Planning and Designing Urban BMPs, 1987)

Various coefficients for smaller storms have also been developed using national datasets and through local research. Municipalities are encouraged to research these and other runoff coefficients or develop their own in determining which method to use within their jurisdiction for use with the 90th percentile storm. Deciding on a single runoff coefficient methodology for a jurisdiction will simplify the design and review process.

Development of a runoff coefficient is done by monitoring the runoff volume produced from a storm event. The runoff coefficient is the ratio between the monitored runoff volume and the total precipitation volume expressed in the following equation and will vary depending on land use and imperviousness of the measured area:

$$R_V = \frac{V_R}{V_P}$$

Where:

R_V = Volumetric runoff coefficient, unitless

V_R = Monitored runoff volume, cf

V_P = Total precipitation volume, cf

The total precipitation volume can be determined using the following equation:

$$V_P = \frac{dA}{12}$$

Where:

d = Precipitation depth, in.

A = Drainage area, sf

It is not the intent of this manual or the Division of Water Quality to recommend specific methodologies. An in-depth summary of runoff coefficients used throughout the country by municipalities and DOTs was developed by the California Department of Transportation (Caltrans) and published as a Technical White Paper titled *Runoff Coefficient Evaluation for Volumetric BMP Sizing*. It can be found here:

http://www.dot.ca.gov/design/hsd/guidance/CTSW-TM-15-312_03_01-Runoff_Coeff_for_Vol_BMP_Sizing.pdf. This white paper specifically discusses Method 1 in more detail.

For all the equations presented below, i represents the percent of imperviousness of the drainage area in decimal format (0.0 – 1.0).

Method 1 – Reese method

Comparing the imperviousness of 44 nationwide sites to their respective calculated volumetric runoff coefficient, a simple linear regression equation was created to estimate the volumetric runoff coefficient for small urban

catchments. Land uses for these sites were classified as residential, mixed, commercial, industrial, and urban open and nonurban (Schueler, Controlling Urban Runoff: A Practical Manual for Planning and Designing Urban BMPs, 1987). Outliers were removed from this dataset by Reese to derive the equation below. Removing outliers from the dataset reduces the impact of erroneous measurements (Reese, 2006).

$$R_V = 0.91i - 0.0204$$

Method 2 – Hydrologic soil groups

Regression equations for runoff coefficient equations were derived based on imperviousness and the NRCS hydrologic soil groups for the 2-year event as presented in [Table 5](#). (Guo, 2013)

Table 5: Runoff coefficient equations based on the NRCS Soil Group.

NRCS Soil Group		
A	B	C/D
$R_{V-A} = 0.84i^{1.302}$	$R_{V-B} = 0.84i^{1.169}$	$R_{V-C/D} = 0.83i^{1.122}$

Method 3 – Granato method

This runoff coefficient is calculated based on a two-line regression model of the runoff coefficient developed by the United States Geological Survey (USGS). This method of developing the runoff coefficient was developed to assist DOTs and contractors to estimate long-term volume reduction for highway projects and has been adopted for use by UDOT. Additional information relating to this runoff coefficient and its applicability can be found in NCHRP Report 792.

$$R_V = 0.225i + 0.05; \quad \text{when } i < 0.55$$

$$R_V = 1.14i - 0.371; \quad \text{when } i \geq 0.55$$

Step 4: 90th Percentile Volume

Calculate the 90th percentile volume using the following equations for V_{goal} or WQV.

$$V_{\text{goal}} = R_V d A \quad \text{or} \quad \text{WQV} = R_V d A$$

Where:

V_{goal} and WQV = 90th percentile volume, cf

R_V = Volumetric runoff coefficient, unitless

d = 90th percentile precipitation depth, ft (convert from inches to feet if required)

A = Project area or BMP drainage area, sf

The two images on the following page show how V_{goal} and WQV are related.

Examples from local case studies and different land uses further demonstrate the usage of these equations. See [Land Use Examples](#) and [Local Case Studies](#).

V_{goal}

V_{goal} is the project's 90th percentile volume retention requirement.

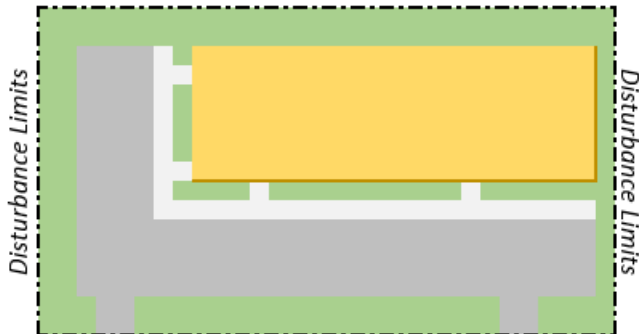

Within the project's disturbance limits (dashed lines):

- V_{goal} is the 90th percentile volume based on the area of the disturbance limits, imperviousness of the disturbance limits, and the 90th percentile storm depth.

WQV

WQV is the 90th percentile volume of the sub-drainage area of each BMP.

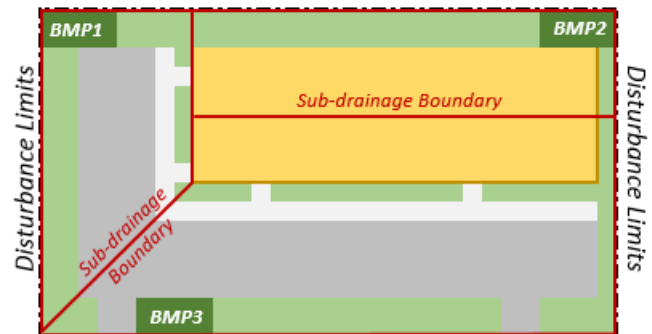

Within the sub-drainage boundaries (red lines):

- WQV is the 90th percentile volume based on the BMP's drainage area, the imperviousness of the BMP's drainage area, and the 90th percentile storm depth.

If the BMP drainage areas are contained within the disturbance limits (as in the figures above), the sum of the water quality volumes for each BMP will equal V_{goal} .

LID BMPs

Introduction

LID BMPs are long-term structures, graded features, or practices that are designed to retain and/or treat runoff close to its origin after construction is complete. Guidance is given in the following areas:

- **Fact Sheets:** The preface and fact sheets contain information on: pollutant removal effectiveness, design criteria, calculation methods, sample calculations, evaluating BMP effectiveness, technical infeasibilities, water quality concerns, a designer checklist, vegetation selection, installation, installation costs, maintenance, maintenance activities, maintenance costs, and a cross-sectional figure.
- **Treatment Trains:** A description of the use and benefits of treatment trains.
- **Proprietary Devices:** A discussion on manufactured devices that have been designed specifically for storm water quality.
- **LID BMP Selection:** How 303(d) listed impairments, TMDLs, and existing and planned land uses should be used to inform the selection of BMPs. Three flow charts are shown for BMP selection based on site conditions and design criteria.
- **Vegetation Selection:** Description of the role of vegetation and guidance on plant selection for BMPs.
- **Land Use Examples:** Hypothetical developments showing a site plan for residential, commercial, and industrial land uses and how an LID approach improves storm water quality.
- **Local Case Studies:** Examples of existing sites within Utah that have implemented LID practices.
- **Additional Local LID Implementation:** An overview four additional LID sites that investigated pollutant removal, vegetation performance, and the relationship between observed runoff coefficients and rain depth, storm duration, and intensity.

LID BMP Fact Sheets

DWQ has developed fact sheets for 12 LID BMPs. These provide guidance for the more common BMPs; however, BMP selection should not be limited to those on this list. They can be found in [Appendix C](#).

LID BMP Type	Fact Sheet ID	LID BMP Category
<i>Rain Garden</i>	BR-1	Bioretention
<i>Bioretention Cell</i>	BR-2	
<i>Bioswale</i>	BR-3	
<i>Vegetated Strip</i>	BR-4	
<i>Tree Box Filter</i>	BR-5	
<i>Green Roof</i>	BR-6	

LID BMP Type	Fact Sheet ID	LID BMP Category
<i>Pervious Surfaces</i>	PS-1	Pervious Surfaces
<i>Infiltration Basin</i>	ID-1	Infiltration Devices
<i>Infiltration Trench</i>	ID-2	
<i>Dry Well</i>	ID-3	
<i>Underground Infiltration Galleries</i>	ID-4	
<i>Harvest and Reuse</i>	HR-1	Harvest and Reuse

Where possible, information that is relevant to all BMPs has been summarized below in this preface instead of repeating identical information in each fact sheet.

Preface to Fact Sheets

Pollutant Removal Effectiveness

Pollutant removal effectiveness is determined from various sources and provides general guidance (Taylor & Barrett, 2014; Filterra Bioretention, 2018; Minnesota Pollution Control Agency, 2018; WERF, 2016; Charlesworth, Beddow, & Nnadi, 2017; APWA, 2012). Many factors contribute to a BMP's pollutant removal effectiveness such as infiltration capacity, climate, vegetation selection, and maintenance practices. Careful collection and analysis of monitoring data is the only definitive method of determining actual pollutant removal for any BMP.

Primary Functions

The BMP's primary functions are listed as a quick reference. Bioretention is the process by which soils and plants remove pollutants from runoff after it has entered the soil. Volume retention describes the BMP's ability to retain runoff and contribute to groundwater recharge. Biofiltration is the process by which pollutants are removed as surface flows interact with grasses, and other vegetation.

Design Criteria

The design criteria for each BMP are based on generally accepted designs. The maximum and minimum ranges are meant to provide a starting point for jurisdictions to develop their own standards, details, and designs. They are not prescriptive. Deviation from the design criteria in these fact sheets is acceptable and encouraged if alternative designs are supported by sound engineering practice, research, or have been shown through past experience to be effective.

Calculation Methods

BMPs are sized for the water quality volume and/or the water quality flow of the BMP's contributing drainage area. The following equations are used for the BMPs in the fact sheets.

Manning's Equation

Applicable BMPs: *Bioswale*, and *Vegetated Strip*

$$Q = \frac{1.49}{n} AR^{\frac{2}{3}} \sqrt{S}$$

Where:

Q = Flow rate, cfs

n = Manning's roughness coefficient, unitless

A = Cross-sectional area of flow, sf

R = Hydraulic radius, sf/ft

S = Longitudinal slope, ft/ft

Continuity Equation

Applicable BMPs: *Bioswale*, and *Vegetated Strip*

$$Q = AV$$

Where:

Q = Flow rate, cfs

A = Cross-sectional area of flow, sf

V = Flow velocity, ft/s

Storage volume within a media with a known porosity

Applicable BMPs: *Rain Garden*, *Bioretention Cell*, *Pervious Surfaces*, *Infiltration Basin*, and *Infiltration Trench*

$$V_{storage} = nV$$

Where:

V_{storage} = Volume of runoff available for storage within media, cf

n = Media porosity, unitless

V = Volume of media layer, cf

Drawdown time

Applicable BMPs: *Rain Garden*, *Bioretention Cell*, *Pervious Surfaces*, *Infiltration Basin*, and *Infiltration Trench*

$$t = \frac{(D_T n_W + d)}{k}$$

Where:

t = Drawdown time, hrs

D_T = Total depth of soil matrix, in

n_W = Weighted average porosity of soil matrix based on soil layer depth

d = Ponding depth, in

k = Design infiltration rate of existing soil or soil matrix, in/hr

Minimum footprint area

Applicable BMPs: *Rain Garden*, *Bioretention Cell*, *Infiltration Basin*, and *Infiltration Trench*

$$A_{min} = \frac{12 \times SF \times WQV}{kt}$$

Where:

12 = Conversion factor (inches to feet)

SF = Safety factor

WQV = Water quality volume, cf

k = Design infiltration rate of existing soil or soil matrix, in/hr

t = Drawdown time, hr

Water quality outlet elevation

Applicable BMPs: *Rain Garden*, *Bioretention Cell*, and *Infiltration Basin*

$$Ele_{WQ} = \frac{WQV}{A_{bottom}}$$

Where:

Ele_{WQ} = Elevation of the water quality volume above basin bottom where overflow is provided, ft

WQV = Water quality volume, cf

A_{bottom} = Area of basin bottom, sf*

*Although stage storage calculations may determine the water quality elevation, using the basin bottom will yield a conservative value.

Volume Reduction

For retention BMPs, the volume reduction is inherent in the sizing of the BMP. For example, a rain garden that is designed to retain 1,000 cf is said to have a volume reduction of 1,000 cf. Volume reduction calculations for bioswales and vegetated strips, however, may not be as simple to quantify due to the variable design considerations such as longitudinal slope, flow rate, and infiltrating capacity of the soils. The information below summarizes a few tools that have been developed by either national research groups or municipalities that may be considered for use.

It is not the intent of this manual to give guidance on the use of these tools or to discuss their applicability at length. Jurisdictions are encouraged to review and apply these tools as deemed appropriate or to develop their own. Jurisdictions are also encouraged to monitor the volume reduction of their own bioswales and vegetated strips to gain a more precise understanding of performance within their jurisdiction to be able to make better informed design level and planning level decisions.

Urban Drainage Flood Control District, Colorado – UD-BMP v3.07

An Excel spreadsheet developed by the Urban Drainage Flood Control District. A multivariable Storm Water Management Model (SWMMM) analysis determines volume reduction based on the user's input of the BMP's drainage area characteristics such as imperviousness and soil type.

The tool can be found by clicking on the link for UD-BMP v3.0 here: <https://udfed.org/software>.

City of Stockton, California – Stormwater Quality Control Criteria Plan Volume Reduction Calculator

An Excel spreadsheet developed by the City of Stockton and the County of San Joaquin. User input determines pre- and post-project volume runoff to determine the expected volume reduction.

The spreadsheet can be downloaded by clicking on the link for the Stormwater Quality Control Criteria Plan Volume Reduction Calculator found here:

<http://www.stocktongov.com/government/departments/municipalUtilities/utilStorm.html>.

NCHRP 25-41 – Volume Performance Tool V.1.0 for Windows

An Excel spreadsheet developed by the National Cooperative Highway Research Program (NCHRP) that allows users to define site characteristics and drainage area characteristics and determine an estimate of the volume reduction percentage for various BMP types. Applicability of this tool is limited to projects within urban highway environments.

The tool can be downloaded by clicking on the link for the .ISO CD-ROM Image found here:

<http://www.trb.org/Main/Blurbs/172415.aspx>.

Sample Calculations

The sample calculations provide one working configuration of a planning level design for each type of BMP. For example, the sample calculations in the rain garden fact sheet assume that the soils infiltrate and that there are no subsurface constraints. However, if a rain garden is required to be lined, an underdrain design and detention time may need to be considered. Different approaches beyond what is shown in the examples might be required and alternate calculation methods are acceptable if they are supported by sound engineering practice, research, or have been shown through experience to be effective.

Consider the following assumptions when reviewing the sample calculations:

- The examples use hypothetical jurisdictional requirements and design criteria to show their role in BMP design. An example may state that the jurisdiction requires 6 inches of freeboard for a BMP, but jurisdictions are encouraged to develop and implement their own design standards.
- The examples have been prepared with the assumption that the BMPs are for water quality purposes only. It is assumed that upstream bypasses have been provided for larger storm events or that overflow structures within the BMP are provided.
- The examples state which method of determining the volumetric runoff coefficient is used for the sole purpose of showing the calculations for the methods discussed in this manual. It is not intended to be an endorsement of a methodology for each BMP type. The appropriate use of runoff coefficients will be determined by jurisdictions.

See *Step 3: Volumetric Runoff Coefficient* in *Developing the 90th Percentile Volume* for additional information.

Evaluating BMP Effectiveness

To evaluate the performance of a BMP, it is necessary to know its purpose for the developed site and to understand the goals for the BMP's watershed. Visiting BMPs during storm events is a highly valuable method for

determining if the BMP is functioning as expected. If the BMP is part of a monitoring program, analysis of monitoring data will reveal if it is performing as designed.

To gain a basic understanding of whether the BMP is functioning properly, performing as expected, and meeting regulatory goals several general questions should be asked that can be applied to all BMPs. Answers to these questions may provide guidance on how to remedy any functionality or treatment issues that arise. The below questions, along with additional considerations specific to each BMP that can be found within the fact sheets, can be used during BMP inspections.

Site-Specific Considerations

1. Are flows reaching the BMP?
 - a. If not, flows have been interrupted and runoff is not being retained or treated by the BMP.
2. Is standing water present at or upstream of the BMP?
 - a. If yes, the BMP may be clogged, groundwater may be entering the BMP, or the storm drain network may be backing up. Standing water can cause mosquito problems.
3. Is sediment collecting at the upstream end before entering the BMP?
 - a. Sediments will ideally be captured in pretreatment (forebay, sump, bioswale, etc.). If significant amounts of sediment are visibly accumulating prior to entering the BMP (either along a curb or within a vegetated area), they should be removed to prevent them from eventually entering the BMP.
4. Does the BMP overflow during large storm events?
 - a. If yes, this could indicate that the designated overflow point is clogged, and it should be immediately corrected.
5. Have changes to the site altered the quantity or quality of runoff that drains to the BMP?
 - a. If yes, the drainage area to the BMP may be larger than the original design, and the BMP will be undersized for its new drainage area.
6. Is the BMP within a jurisdiction's database and is it being regularly maintained by the responsible party?
 - a. If no, the BMP will likely fail. See the individual BMP fact sheets for specific maintenance activities that will prolong the lifespan of the BMP.
7. Has the public raised concerns about the BMP?
 - a. If yes, address concerns or, if no modification is necessary, provide education on BMP functions and protective measures that are in place.

Watershed Specific Considerations

1. Is the BMP located within a 303(d) listed watershed, and does the watershed have an approved TMDL?
 - o If yes, prioritizing the BMP for monitoring should be considered.
2. Was the BMP designed to address specific TMDL approved impairments?
 - o If yes, monitoring will provide data to support the BMP's performance.
3. Has upstream and downstream monitoring equipment been set up for the BMP, and is it functioning?

- If yes, analyze data of the monitored parameters to determine the BMP's effectiveness.
4. Does monitoring data show that targeted pollutants are being removed?
- If no, investigate further to determine causes for the BMP's inability to remove the targeted pollutants.

Technical Infeasibilities

It may be technically infeasible to install BMPs at the project site. When this is the case, the site is not required to retain the full project volume retention goal; however, an MS4 may require that an alternative compliance option be utilized (See *Alternative Compliance and Credit Systems*). Technical infeasibilities will be related to depth to the historical high groundwater, soil conditions, project boundaries, economic factors, or other reasons. Possible technical infeasibilities have been categorized below by BMP type.

General Infeasibilities

- Insufficient project space
- Inadequate maintenance access
- Public safety concerns or BMP is unable to be designed in a way that is compatible with jurisdiction's safety standards
- Insufficient head to allow for proper BMP drainage
- Utility conflicts that cannot be resolved

Bioretention/Infiltration/Detention

- High groundwater that does not allow for the minimum separation between the bottom of the BMP and the water table. Infiltration may also exacerbate existing downstream groundwater concerns.
- Poorly infiltrating soils
- Proximity to structures that may result in compromising geotechnical, foundation, or structural integrity (though detention may still be an option with an impermeable liner)
- Steep slopes that may be compromised by infiltration

Pervious Surfaces

- Pervious surface would not provide sufficient load bearing strength for heavy loads
- Storage beneath pervious surface would threaten the stability of adjacent subgrades

Harvest and Reuse

- There are no opportunities for reuse within the contributing drainage area
- A harvest and reuse system cannot be practically designed without significant impact on the project

Water Quality Concerns

General Concerns

Negative impacts on water quality from the construction and maintenance of LID BMPs can generally be avoided in the development's design phases. On the planning level, water quality degradation can be avoided by considering the proximity of BMPs to environmentally sensitive areas such as landfills, areas with known

groundwater contamination, and wellhead protection areas. Retention at these locations is not advised, as it has the potential to mobilize contaminated groundwater and degrade down-gradient groundwater or drinking water quality. Pollutants can become concentrated within the soils at BMP locations, which may further exacerbate existing groundwater contamination. Installing BMPs without consideration to geotechnical conditions such as high groundwater and poor soils can lead to a failed BMP that results in degraded water quality that in turn interacts with groundwater and receiving waters. Compaction of soils at the bottom of a BMP or within a soil matrix that is meant to infiltrate will likely result in standing water, vector issues, or algae. Poorly maintained BMPs will result in many possible modes of failure such as standing water, vector issues, algae, flooding, failed soils, or other issues which will compromise the integrity of groundwater or adjacent receiving waters.

Designer Checklist

The designer checklist provided on each BMP fact sheet may be used by those who are designing or reviewing the design decisions that were made for each BMP. Engineering judgment should be used for all design decisions and LID approaches. Consider including information from the designer checklist in the Storm Water Quality Report.

Vegetation

Ensuring that vegetation remains healthy will increase the likelihood that the BMP remains aesthetically pleasing and performs as expected. See *Vegetation Guidance by BMP Type* for additional information.

Installation

LID BMPs should be taken offline during construction so that flows within its drainage area do not enter the BMP until construction is complete. They should not be used as construction BMPs. Use as a construction BMP can compromise functionality and decrease lifespan. They should not be allowed to become compacted during construction.

Typical installation activities for each BMP can be found within each BMP fact sheet.

Installation Costs

Refer to each BMP fact sheet for a general list of construction items. The Green Values National Stormwater Calculator summarizes BMP construction costs and can be found here:

http://greenvalues.cnt.org/national/cost_detail.php. Costs will vary.

Maintenance

Proper maintenance will significantly improve the functionality of the BMP and increase its life span. Maintenance activities typically include semiannual (Spring and Fall) inspections but may be required more often such as shortly after construction or after significant storm events. Documentation of maintenance activities is encouraged to provide a record of inspection frequency, maintenance activities, and associated costs.

Maintenance agreements between the municipalities and the final owner of the BMP (if not the MS4) should identify key maintenance elements such as: transfer of BMP ownership; a description of maintenance activities and who is expected to perform them (owner, municipality, other); and, a method of resolution should violation of the maintenance agreement occur.

A description of typical maintenance considerations for each BMP type is given below.

Bioretention/Infiltration/Detention/Harvest and Reuse

- Inspect for sediment buildup or pollutant accumulation within or upstream of BMP and remove if present. Inspection of underground systems may require an access port such as a manhole.
- Inspect for and remove trash and debris.
- Determine cause of any standing water within BMP and remediate.

- Ensure that vegetation is established and maintained.
- If underdrains have been installed, ensure that they are functioning properly.
- If irrigation system has been installed, ensure that it is functioning properly.
- For green roofs, additional inspection of the roof structure may be required.

Pervious Surfaces

- Inspect for clogging of pervious surfaces
 - Vacuum or sweep the pavement to remove sediment and debris.
 - Power wash if necessary. Prior to power washing, downgradient inlets (if present) need to be protected to prevent sediments from entering storm drain system.
- Inspect for depressions. Depressions will indicate that the subsurface layers are failing or have failed. Regrading may be required.

Maintenance Activities

Detailed descriptions of maintenance activities, inspection frequencies, actions that can be taken to resolve maintenance issues, and the general level of effort associated with maintenance activities can be found in each BMP fact sheet.

In determining the inspection effort, the following descriptions were used:

Low – Visual inspection only required to make determination of possible required maintenance activity.

Medium – Visual inspection and other physical activity is required, such as opening an observation or a manhole lid; or, visual inspection and training is required, such as identifying invasive species, to make determination of possible required maintenance activity.

High – Visual inspection, physical activity, and training is required to make determination of possible required maintenance activity.

Maintenance Costs

Maintenance costs are tied to maintenance activities. Inspection of BMPs requires either an onsite presence that is tasked with performing the inspections or a designated person or persons who must visit the BMP to perform the inspection. In either case, the inspector(s) will need to be trained to make correct determinations of the next maintenance activity (if any) for any given maintenance issue that is required to remedy a failing or poorly maintained BMP (Figure 11). Permittees are required and private owners are encouraged to track operations and maintenance activities and associated costs.

In general, the following items are considered when considering maintenance costs: inspection frequency, inspection duration, crew size, machinery costs, and remediation. Remediation costs will vary widely based on the action required.



Figure 11: Standing water after a rain event at a bioretention BMP.

The Green Values National Stormwater Calculator summarizes a range of BMP maintenance costs and can be found here: http://greenvalues.cnt.org/national/cost_detail.php.

Figures

The figures for each BMP show a general cross-section that is a starting point for site-specific design. Use of these figures is appropriate for planning level design. For project design, the level of detail, the layout, and cross-sections for the selected BMPs should meet the municipality's CAD and design standards and include all information required for construction.

Treatment Trains

Treatment trains are a configuration of BMPs in series designed to achieve a pollutant reduction goal or a volume retention goal. Treatment trains are commonly used when a BMP can provide pretreatment to a downstream BMP. An example of this is shown in [Figure 12](#) at a site that is under development where a swale will provide pretreatment for the downstream dry well. Another scenario where a treatment train may be appropriate is when additional BMPs are needed to adequately provide volume retention. A scenario where this applies is where a rain garden has insufficient space to retain the entire water quality volume, but there is available space for an upstream bioswale that can provide additional retention. Site design practices can also be part of a treatment train (WEF Press, 2012).



Figure 12: A vegetated swale that will provide pretreatment for a dry well.

Treatment trains that keep runoff onsite have been found to be more effective. For this reason, BMPs that provide physical, chemical, and biological treatment are good candidates as these processes occur within BMPs that are designed to capture runoff. Pollutant reduction primarily occurs within the most upstream BMP. This is due to the theory of irreducible pollutant concentrations. Irreducible pollutant concentrations occur because of the BMP's inability to adsorb and degrade pollutants beyond a certain concentration (Schueler, *Irreducible Pollutant Concentrations Discharged from Stormwater Practices: The Practice of Watershed Protection*, 2000). Treatment train configuration should be considered carefully based on the water quality goals and targeted pollutants at the site.

Proprietary Devices

Proprietary devices, such as tree box filters ([Figure 13](#)), media filters, and underground chambers use proprietary designs, soil mixes, aggregates, and other technologies to accomplish volume retention and storm water treatment.

Consideration of proprietary devices, as with other LID BMPs, should occur at the planning level. These devices function well in highly urbanized areas where there is limited room for other treatment options. Drainage areas with high imperviousness will require that the device have a larger footprint. A common design criterion for the size of the proprietary devices is the flow-through rate and are often referred to as flow-through devices.



Figure 13: Proprietary tree box filter

These devices and technologies are typically designed with the help of the manufacturer. An approved list of vendors, devices, or other technologies may be written into a municipality's storm water management plan. Manufacturers will also be able to provide maintenance activities and inspection frequencies associated with the device. Discussion of specific proprietary devices within this manual does not constitute an endorsement of the device; nor does exclusion of a device constitute a lack of endorsement. Municipalities are responsible for determining which devices and technologies to use within their jurisdiction at the planning or project level.

Tree Box Filters

Tree box filters are typically contained within a concrete vault if being designed as a flow-through device. The vault bottom is removed if it is decided that infiltration is an appropriate function of the filter. See the [Tree Box Filter](#) fact sheet for additional information.

Engineered Soils

Engineered soils can be manufactured soil mixes or mixes that are known by a jurisdiction to perform as desired. They can be used to achieve various water quality goals such as pollutant removal, volume storage, or supporting vegetation when existing soils may not be adequate. They are composed of proprietary and non-proprietary materials such as crushed stone, soil, clay, rock, sand, or other proprietary materials developed by the manufacturer.

Underground Detention or Retention

Underground systems, such as chambers, are installed beneath project surfaces that already serve a function, such as parking, when there is limited space within the project limits to provide above ground detention or retention. These systems can be designed for flood control volumes or for the 90th percentile volume. See the [Underground Infiltration Galleries](#) fact sheet for additional information.

Others

Aggregate composition, concrete pavers, grass pavers, pervious concrete mixes, permeable asphalt mixes, hydrodynamic separators, and snouts are all examples of types of proprietary devices and technologies. Jurisdictions are encouraged to seek out and determine which devices are appropriate for their projects.

LID BMP Selection

Selection of BMPs is based on many factors. At the planning level, receiving waters, 303(d) impairments, TMDLs, land use, and watershed management plans will play a role in determining which BMPs are most appropriate. At the project level, project limits, groundwater, contaminated soils or groundwater, poorly draining soils, and connections to the storm drain network are all variables that will guide the project team toward BMP selection. The following sections provide tables and charts that can be used to assist in the selection of appropriate BMPs.

BMPs Categorized by 303(d)/TMDL

[Table 6](#) summarizes pollutants that are included on the 303(d) list of impairments or that have approved TMDLs within at least one watershed in Utah along with BMPs that are effective at addressing the pollutant. In general, all BMPs are effective at addressing one or more pollutant impairments but special considerations should be taken into account as shown by footnotes provided at the end of the table. Specific BMPs are not identified for categories in which pollutant removal effectiveness is not rated.

Table 6: BMP types rated for the removal of pollutants that are either 303(d) listed or have approved TMDLs within Utah.

Pollutant	Category	BMP Type
E. coli	Bacteria	All
Total Coliform		
Dissolved Oxygen	Dissolved Oxygen	All ¹
Total Dissolved Solids	Dissolved Solids	BMPs that prevent erosion of sediments
Cadmium	Metals	All
Zinc		
Aluminum, Dissolved	Metals (Dissolved)	All
Arsenic, Dissolved		
Cadmium, Dissolved		
Copper, Dissolved		
Iron, Dissolved		
Lead, Dissolved		
Mercury, Dissolved		
Zinc, Dissolved		
Ammonia	Nutrients	All ²
Boron		
Boron, Total		
Nitrate as N, Total		
Selenium		
Selenium, Dissolved		
Total Ammonia		
Total Phosphorus		
Observed/Expected (OE) Species Bioassessment	OE Bioassessment	All
pH	pH	All ¹
Gross Alpha	Radioactivity	BMPs that prevent erosion of sediments
Radium		
Sediments/TSS	Sediment	All
Temperature	Temperature	BMPs that incorporate shading and promote infiltration

¹Improving dissolved oxygen levels and pH values are tied to nutrient reduction.

²BMPs may increase nutrients in the effluent if fertilizer is used.

BMPs Categorized by Land Use

Residential, commercial, industrial, and agricultural land uses produce unique assemblages of pollutants. Sediments, pet waste, fertilizers and pesticides are common pollutants in residential areas. Pollutants in commercial and industrial land uses vary depending on site activities. Landscaping, outdoor storage, metal roofs, food, and animal waste products will determine which pollutants may be expected. [Table 7](#) summarizes expected pollutants by land use.

Table 7: Expected pollutants by common land uses.

Land Uses	Expected Pollutants				
	Sediment	Nutrients	Metals	Bacteria	Oil/Grease
Residential	Y	Y	N	Y	Y
Commercial	Y	Y	N	N	Y
Industrial	Y	N	Y	N	Y
Transportation	Y	Y	Y	Y	Y
Landscaped Areas	Y	Y	N	N	N
Agriculture	Y	Y	N	Y	N

BMP Selection Flow Charts

Selection of LID BMPs is determined by site constraints. There may be geotechnical constraints that govern BMP selection such as shallow groundwater or poor soils, which could rule out the possibility of retention. When retention is not feasible, treatment of runoff can still be accomplished. Treatment can be achieved by creating soil layers or adding amendments to existing soils through which runoff will travel to remove pollutants. Impermeable liners may need to surround the soil layers to prevent groundwater intrusion or to protect adjacent structures. Underdrains should also be considered to allow the BMP subsurface to drain. An example of this would be a rain garden used at a project with high groundwater that has been designed with soil layers, underdrains, and an impermeable liner. Treatment is still achieved but retention does not occur.

Three flow charts have been developed to assist in the selection of appropriate BMPs. The flow charts guide the user through the general BMP evaluation and selection process. Ultimately, BMP selection will be site-specific; BMP recommendations contained within the flow chart do not necessarily rule out consideration of other BMPs.

Flow Chart 1: Retention vs Treatment

Based on site conditions, determine if retention or treatment will be used.

Flow Chart 2: Retention BMP Selection

Determine which BMPs will provide retention based on the design criteria and technical criteria of each BMP.

Flow Chart 3: Treatment BMP Selection

Determine which BMPs will provide treatment based on the design criteria and technical criteria of each BMP.

Flow Chart 1: Retention vs Treatment

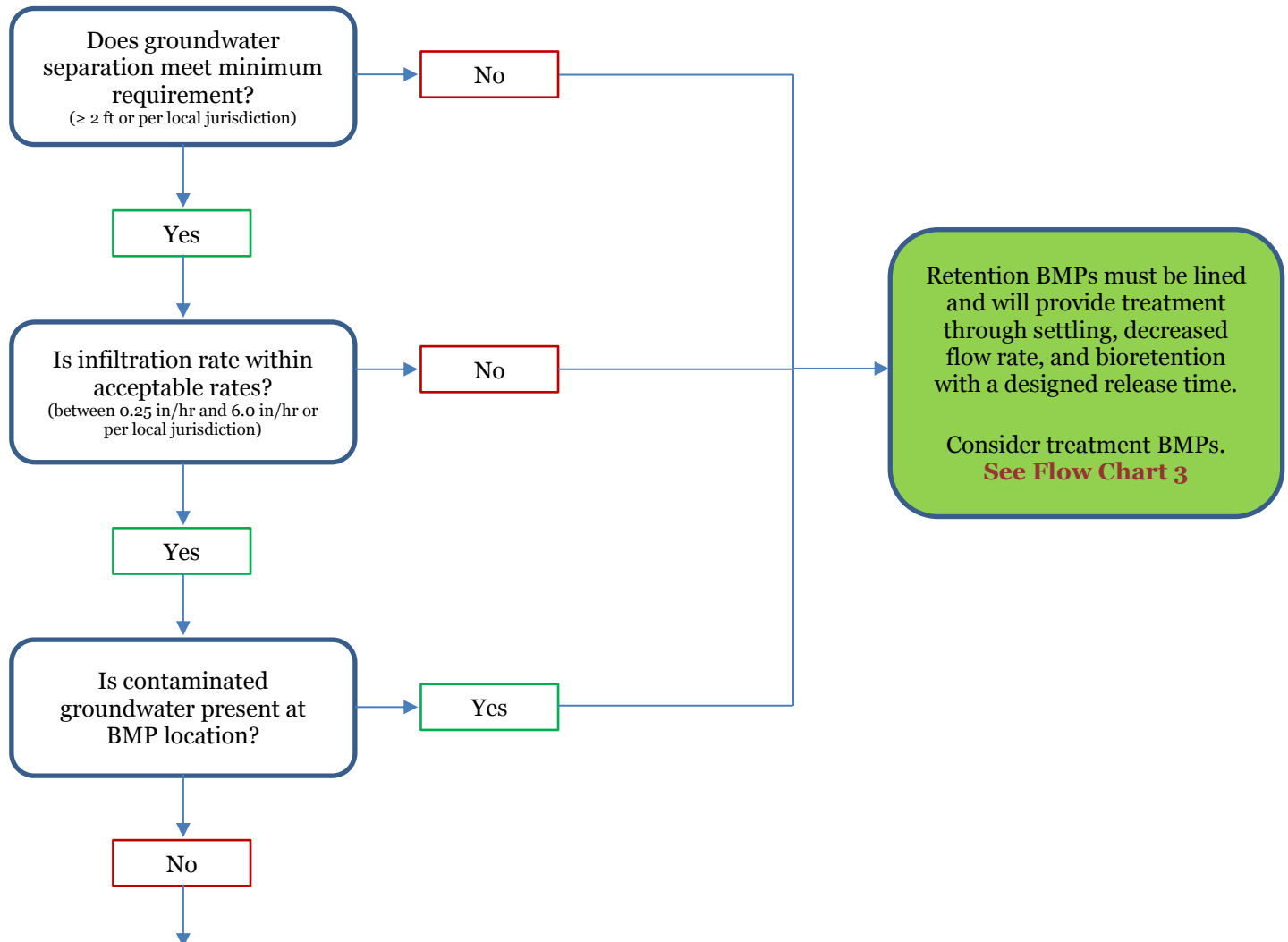

Proceed with retention BMP consideration. Determine infiltration rate with field testing for final design.
See Flow Chart 2

- | | |
|---|--|
| <p><u>Retention BMPs¹</u>
 Rain Garden
 Bioretention Cell
 Green Roof
 Pervious Surface
 Infiltration Basin
 Infiltration Trench
 Underground Infiltration Galleries
 Dry Well
 Proprietary Devices
 Harvest and Reuse³
 Other</p> | <p><u>Treatment BMPs²</u>
 Bioswale
 Vegetated Strip
 Tree Box Filter
 Proprietary Devices
 Harvest and Reuse³
 Other</p> |
|---|--|
- ¹When retention BMPs are infeasible, they may still provide treatment by using impermeable liners and underdrains.
²Bioswales may function as retention devices if soils permit and if a raised outlet is provided.
³Harvest and Reuse may be considered a retention BMP or a treatment BMP depending on the application.

Flow Chart 2: Retention BMP Selection

Note: BMP recommendations contained within this flow chart does not necessarily rule out consideration of other BMPs.

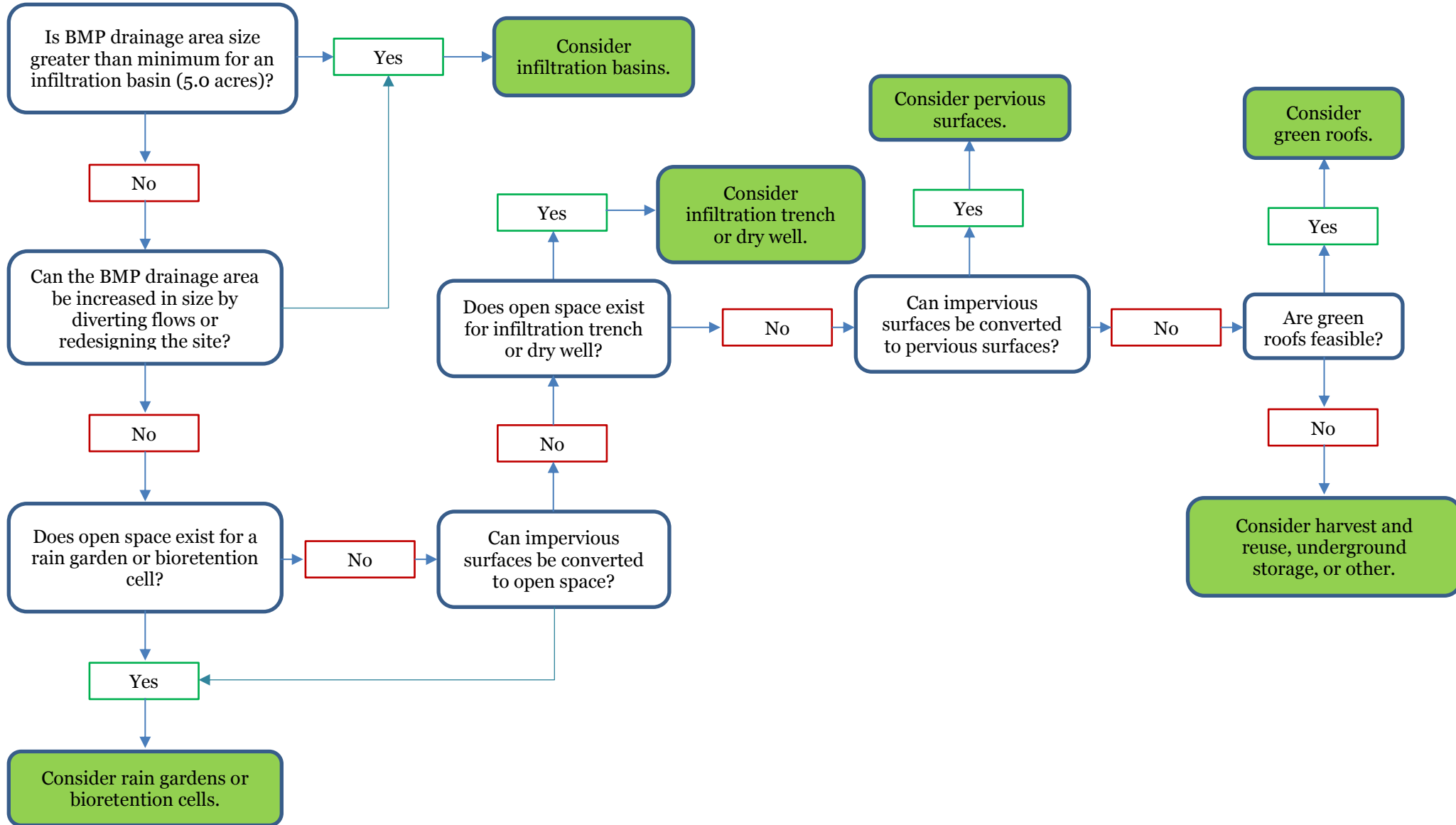

Flow Chart 3: Treatment BMP Selection

Note: BMP recommendations contained within this flow chart does not necessarily rule out consideration of other BMPs.

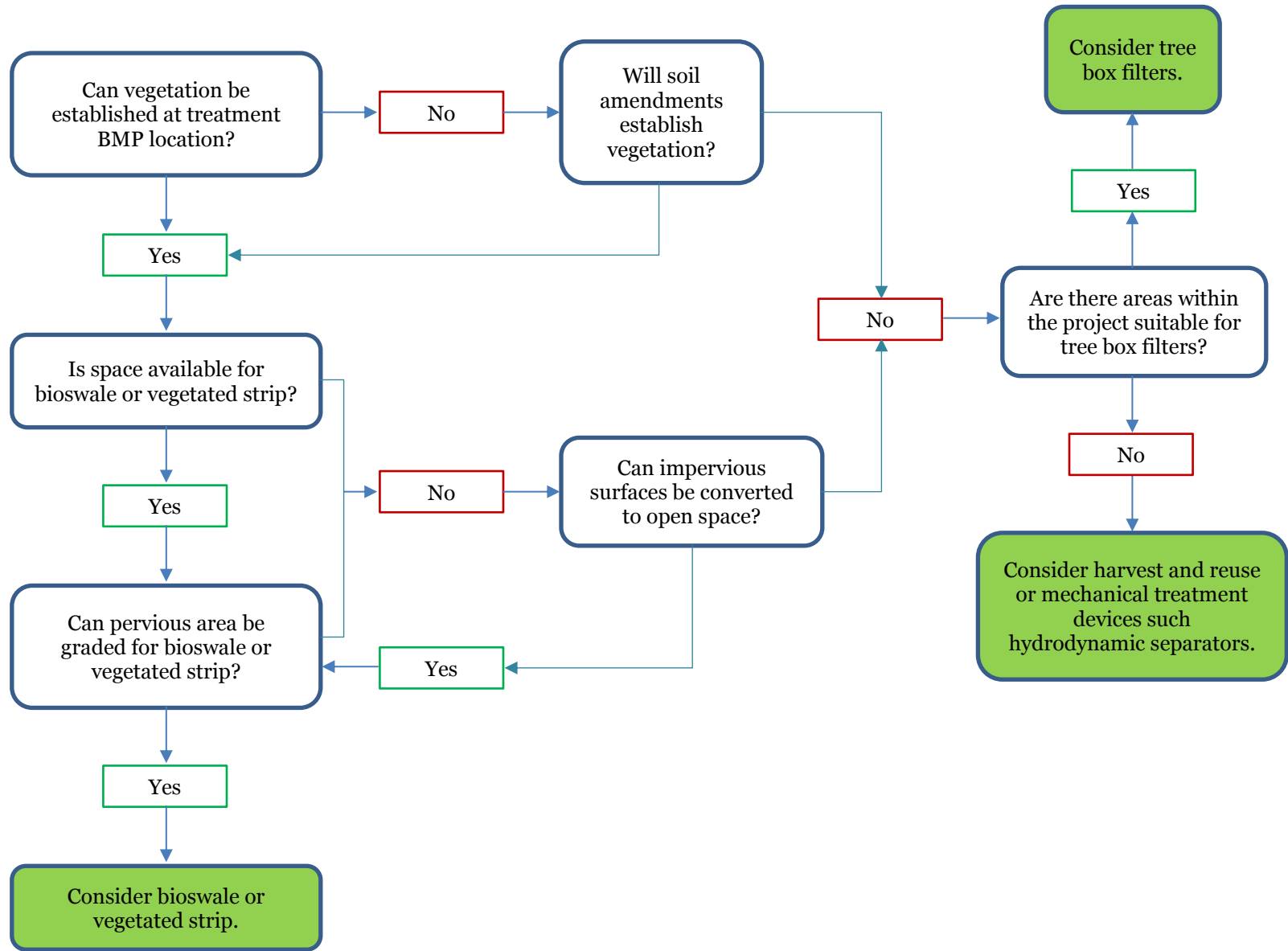

Vegetation Selection

Benefits of Using Vegetation in BMPs

Vegetation plays a vital role in the viability of BMPs. In conjunction with engineered systems, they reduce pollutants through plant uptake, protect soils from further erosion, increase percolation rates, provide habitat for wildlife, increase aesthetic appeal of BMPs, contribute to mental health, and reduce heat retention.

Pollutant Reduction

Phytoremediation is another benefit of plant use in BMPs. Plants, can uptake pollutants through their root systems and utilize the contaminants to promote vegetative growth above ground, thereby removing the pollutants from soils and water. Generally, this method is more cost effective than other engineered approaches, which may create secondary contaminated waste that must be treated and disposed of in special landfills and through expensive treatment systems. Furthermore, when appropriate plants are selected, it does not have a negative impact on the plant itself as the nutrients are utilized for proper growth and functions of the plant. In conjunction with microbes, they break down otherwise harmful pollutants and either minimize pollutants to acceptable levels or reduce them altogether.

The percent of vegetative coverage has a direct impact on the pollutant reduction performance of the BMP. During a 2-year monitoring study of roadside vegetation by the Caltrans Division of Environmental Analysis, it was found that a minimum coverage of at least 65% was needed for pollutant reduction to occur, but that there was a significant decrease in pollutant reduction below 80% (Caltrans Division of Environmental Analysis, 2003). This result is consistent with similar studies that have led to minimum vegetative requirements for various permittees nationwide that range from 65% to 80%.

Protect Soils from Erosion

Soil erosion occurs when soil is removed through the action of wind and water at a greater rate than it is formed. Plants prevent soil erosion by providing protective cover, slowing down runoff and holding the soil in place. As raindrops fall directly on the soil the impact displaces small particles of soil causing erosion. Plants and plant litter protect the soil from the effects of raindrop impact. Vegetation that completely covers the soil and intercepts all falling raindrops on or close to the surface are the most effective in controlling soil erosion. Additionally, by slowing down runoff, fewer soil particles are carried downstream and surface water can soak into the soil. Plant cover also protects soil against wind erosion. A lack of wind breaks, such as trees, shrubs, and groundcovers, allows the wind to further displace soil particles for longer distances, increasing abrasion and erosion. Furthermore, plant roots help to bind the soil, reducing wind and water displacement. Roots also help to stabilize embankments and slopes, limiting the risk of landslides.

Mulch also adds additional protection from erosion, especially in newly seeded areas. Like vegetation, mulch protects the ground from wind and water erosion while seeds germinate and reduces the loss of soil moisture which, if not maintained, makes the soil more susceptible to wind erosion.

Increase Percolation Rates

Plant litter, root systems, and the microbes associated with the soil environment increase percolation rates through soils. This occurs due to increased air pockets within the soil created as roots expand and contract and decomposed vegetative material is incorporated into the soil. Additionally, the use of water by the plants as they grow draws water through the soil to the roots and increases the permeability of soil over time through constant microscopic movement within the soil itself. Together, these processes create voids in the soil structure allowing water to freely move through the soil either into plant roots for uptake or down into the groundwater below.

Provide Habitat for Wildlife

Vegetation plays a vital role in the quality of wildlife habitat. Plants offer wildlife food, shelter, water, and space needed to exist. Edge areas, especially where water occurs, offers secluded places for wildlife to forage without disturbing the BMPs. When wider habitat areas are provided, especially along edges, they provide a haven for wildlife. Furthermore, when wildlife occupies the area they contribute to vegetation distribution and help to control growth.

Increase Aesthetics

Form, line, color, and texture are the basic visual components of art, and their combination provides visual interest and aesthetic appeal. A good mix of plants with their varied physical characteristics adds beauty and aesthetics to the landscape. Some plants may have more value as a visual element in the landscape based on their physical characteristics. Some characteristics are more visually dominant and have a higher visual value, some are more functionally dominant, and some dominate simply by size. Upright forms, bright colors and coarse textures are dramatic and have high visual impact. Low or prostrate forms, dull colors and fine textures are calm and have low visual impact. The visual value of all plants is dependent on the distance from which they are viewed, the time of year, the quality of light, the adjacent plants, and the plants' health.

Creatively using vegetation within BMPs reduces negative visual impacts of the BMP, makes them more visually pleasing, and increases acceptance of BMP practices within urbanized areas, especially where residential areas are involved. Each plant must be considered individually when selecting plants for a composition, but the entire composition takes on greater importance than the individual plants. For this reason, it is important to think about how the characteristics of each plant will relate to the plant or hardscape next to it.

Contribute to Mental Health

Plants generally have a positive influence on mental health. In increasingly urbanized and developed areas, they provide respite and a sense of connectivity to nature.

Reduce Heat Retention

Vegetation also can mitigate the effect of heat islands created by development. By increasing areas for plants to grow, including within BMPs, increased shade is provided. The added shade combined with evapotranspiration naturally occurring from plants creates a cooling effect. Furthermore, trees and vines planted near buildings help to provide shade and insulation to existing buildings which provide a cooling effect and helps to mitigate cooling costs associated with urban living. One study that analyzed cost savings in Ft Collins, CO, Cheyenne, WY, Bismarck, ND, Berkeley, CA, and Glendale, AZ showed that a net savings of \$30-\$90 per tree (\$40-\$120 when adjusted for inflation) was achieved by planting trees in urban environments. (McPherson, Simpson, Peper, Maco, & Xiao, 2005).

Coordinating with a local Utah State University extension or a local nursery can help ensure appropriate plants are chosen for a project.

Vegetation Considerations

In choosing plant species for LID, several considerations need to be made to ensure establishment and long-term plant health. Factors that should be considered include: adaptability of plants to the site conditions, water consumption requirements, soil types, the ability to withstand air and soil pollutants, and heat and cold tolerances.

Site Conditions

When selecting vegetation for LID sites, it is critical to consider the needs of the plants and match them to the current and future site conditions. As the landscape transforms into a built environment, it is important to understand that the minimum and maximum temperatures will change, and microclimates will be created. As the

heat index increases, evapotranspiration rates will also increase. Reflected heat off pavement, concrete, and glass can also burn plants. Furthermore, natural drainage patterns are altered as buildings and infrastructure are developed changing the soil structure and porosity, nutrient availability, and availability of water. Therefore, plants selected must be adaptable to and be tolerant of the changing site conditions. Their ability to improve water, soil and air quality and reduce the heat island effect caused by development should also be considered. Species native to the project area are often better suited to current site conditions; however, plant materials adapted to the changing site conditions may also be a good choice.

Water Requirements

In the arid environment of Utah, it is critical that plants are drought tolerant. This not only helps reduce plant stress, but conserves water. Plants that are not well adapted to the region will tend to be more stressed and therefore, require more water, nutrient supplements, and overall management. The use of additional fertilizer to aid stressed plants can contribute to water pollution. Plants that are not suitable to more arid environments are generally not a good choice for Utah landscapes.

Many municipalities have landscape ordinances that require minimum vegetative cover or percentages of trees and shrubs. In most cases, these landscape ordinances do not preclude the use of native or water wise vegetation. Additional planning and careful selection may be needed to meet these and any other aesthetic requirements.

Fluctuation in soil moisture conditions is also a critical consideration. Typically, plants that can tolerate wide fluctuations in soil moisture, including saturated conditions with standing water, are good choices for basins, swales, bioretention cells, rain gardens, and tree box filters while plants needing good drainage are better suited to basin slopes and upland areas.

Soil

Some plants prefer growing in consistently moist soils while others prefer dry soil with only intermittent changes in moisture levels. Also, the soil's alkalinity, salinity and soil structure are important factors. For example, plants that tend to do well in dry, shallow, rocky soils with a higher tolerance for salt buildup will tend to do better in rooftop gardens compared to plants that prefer acidic bog-like conditions that are better suited to a bioretention cell or rain garden.

Another factor to consider is the soil's structure as it impacts the root system of plants. Plants with shallow surface roots would not be an appropriate choice for areas that may be inundated with heavy flows of surface water, while those with deep taproots would be a better choice.

Plants that have a proven ability to tolerate soil compaction, increased heat, and reduced air flow are best suited for landscape strips. Parking lots along streets require plants that can produce strong tap roots, especially for trees which may otherwise blow over in wind gusts.

It is also important to consider the soil in relation to microbes and plant material, especially for tree box filters and bioretention cells. Plants, soil, and microbes work symbiotically in these situations to alter or reduce the quantity of pollutants collected in storm water and rain water. Some of the nutrients are utilized directly by the plants and soil microbes reducing them to acceptable levels. Selecting plants that are effective at pollutant reduction will ensure that the pollutants are not toxic to the plants.

Air Quality

Plant tolerance to air pollution is another important consideration. Some plants thrive in higher carbon pollutant environments, for example, while others may experience stunted growth. Air pollutants to consider include: carbon monoxide, ground-level ozone, lead, sulfur dioxide, particulate matter, and nitrogen dioxide.

Heat and Cold Tolerance

In addition to soil and water considerations, heat and cold tolerances of plants should be considered. The map of plant hardiness zones in [Appendix D](#) identifies areas by the lowest annual minimum temperature. Plants associated with each zone are identified in [Appendix E](#) and are generally tolerant of the coldest temperatures in the area. The other consideration is heat tolerance of plants, which in drier and hotter desert regions is equally important and can be detrimental to plant health. This information can be found using the American Horticultural Society Heat Zone Map for the United States (<http://www.ahsgardening.org/gardening-resources/gardening-maps/heat-zone-map>). The map identifies the average number of days a specific area experiences extreme heat. Also, it is important to consider the reflectivity of surfaces such as buildings and sidewalks on leaves and bark. Highly reflective surfaces tend to increase the ambient temperature around plants and can injure them to the point of plant death.

A plant selection matrix containing appropriate trees, grasses, shrubs, and groundcover for the LID BMPs covered in this manual is provided in [Appendix E](#).

If applicable to the site, vegetation for BMPs should meet the following conditions:

- Vegetation is adapted to the local climate, considering seasonal temperature ranges and average rainfall, exposure to direct sun, frost, wind, and desired irrigation practices.
- Plants selected are tolerant of weather conditions at the specific site such as extreme high and low temperatures, strong winds, sun, and snow. ([Appendix E](#) contains a matrix of example plants identified by climate zones within Utah and BMPs for each.)
- Vegetation is tolerant of varied moisture conditions (wet and dry).
- Plants are adaptable to varying soil types and conditions.
- Species are non-invasive for the area and site conditions (will not readily spread by air, seed transport, or root invasion).
- Flora is resistant to wildlife foraging such as deer, elk, and rabbits and local pests and diseases.
- Vegetation provides habitat value and linkages to larger open spaces on the fringe of urban developments.
- Site maintenance requirements (e.g., invasive root growth, pruning, thinning, dead-heading), site accessibility, and the ability of the property owner to maintain the specific vegetation is feasible.
- Vegetation adheres to local design criteria such as height limitations and approved plant lists.
- Plants are readily available in local or regional nurseries.
- Flora has an attractive appearance and aesthetic value.
- Vegetation is appropriate for the type of pollution present and desired pollutant removal.

[Vegetation Guidance by BMP Type](#)

Bioretention/Bioswales/Infiltration/Detention

Typically, bioretention BMPs receive greater pollution due to storm runoff from streets and roadways; and these BMPs receive water after every storm event. As a result, they require plants that:

- Have a greater ability for nutrient uptake and pollutant neutralization.
- Can survive in boggy and moist soils.

- Tolerate salt or other de-icing agents.

Infiltration Basins

Infiltration basins generally hold water for longer periods of time; however, only the bottom of the basins hold the standing water. Plants located in the bottom of the basin must be able to tolerate standing water for several days, while plants located on the side slopes must be able to tolerate drier conditions. Select plants in infiltration basins that:

- Withstand being covered with water for up to 72 hours.
- Reduce the need for supplemental irrigation and maintenance.
- Do not require additional fertilization and thereby reduce polluted runoff potential.

Vegetated Strips

Vegetated strips are typically small and have limited planting space, so selection must consider the overall size in conjunction with safety requirements. Select plants that:

- Do not require additional fertilization and thereby reduce polluted runoff potential.
- Tolerate environmental factors such as reflective pavements and building materials, salt or other de-icing agents, and air pollution at the site.
- Withstand trampling and vandalism in urban conditions.

Green Roofs

Plant material selection should be based on factors determined by the type of green roof desired, structure itself, as well as the long-term maintenance the owner is able to provide. Typical green roof vegetation ranges from low-growing succulent plants (e.g., Sedums) or groundcovers (characteristic of extensive green roofs) to an assortment of native grasses, shrubs, and trees (more typical of intensive green roofs). Plants of the genus *Sedum* (family Crassulaceae), which are low-growing succulents, are often used for green roofs because of their resistance to wind, frost, drought, and fire. A mix of *Sedum* and other succulent plants is recommended because they possess many of the recommended attributes. Herbs, forbs, grasses, and other low groundcovers may also be used but typically require more irrigation and maintenance. Use of native vegetation is preferred though some natives may not thrive in the rooftop environment; thus, a mix of approximately 80% *Sedum*/succulent plants and 20% native plants generally recognized for their hardiness is recommended, particularly for extensive green roofs (Velazquez, 2005). Select plants that:

- Grow in a shallow and porous substrate (i.e., grasses, perennials and groundcovers are suited to roofs with a substrate of 3-7 inches minimum).
- Root system depth requirements matches depth of substrate (i.e., plants with a deeper and more extensive root system such as shrubs and some trees require 48 inches of substrate minimum depth).
- Drought tolerant and able to exist with minimal and infrequent watering, especially once established.
- Able to withstand higher wind speeds.
- Tolerant of full-sun conditions.
- Fire resistant.
- High salinity tolerance.

- Lower maintenance requirements since access is limited.
- Are primarily non-deciduous to provide adequate foliage cover year-round and reduce erosion potential.
- Have good regenerative qualities (i.e., perennial or self-sowing).
- Are low maintenance (i.e., no fertilizers, pesticides, or herbicides, little or no mowing or trimming).
- Have growth patterns allowing vegetation to thoroughly cover the soil (at least 90% surface area coverage should be achieved within 2 years).
- Are compatible with the aesthetic preferences of the owner and future building occupants who may utilize the roof as a green space.

Steps to Selecting Vegetation for BMPs

To identify vegetation for specific sites and BMPs, consider the following steps:

1. Consider consulting with a landscape architect and/or horticulturalist to assist in the appropriate selection and design for each BMP in conjunction with other professionals such as engineers and architects.
2. Identify the hardiness zone(s) at the site.
3. Identify which BMPs will be used.
4. Determine if there are any microclimates within the site that need to be considered.
5. Identify plants that will best work for the BMP based on the hardiness zone and site's microclimates (See [Appendix E Utah Plant Selection Matrix by Climate Zone and BMP](#) for more information.)
6. Develop a landscape plan that considers site conditions, erosion protection, pollutant mitigation, human use of and interaction with the site, creation of wildlife habitat, aesthetics, and site and BMP maintenance.

Land Use Examples

The following examples show possible implementations of LID BMPs for three land use types: residential, commercial, and industrial. Figures in the examples are conceptual and as such are not to scale and do not show details for final design.

Residential LID

Development size: 6.61 ac

Imperviousness: 0.51

Volumetric runoff coefficient: 0.17

90th percentile storm depth: 0.55 in

Hydrologic soil group: B

Residential Development

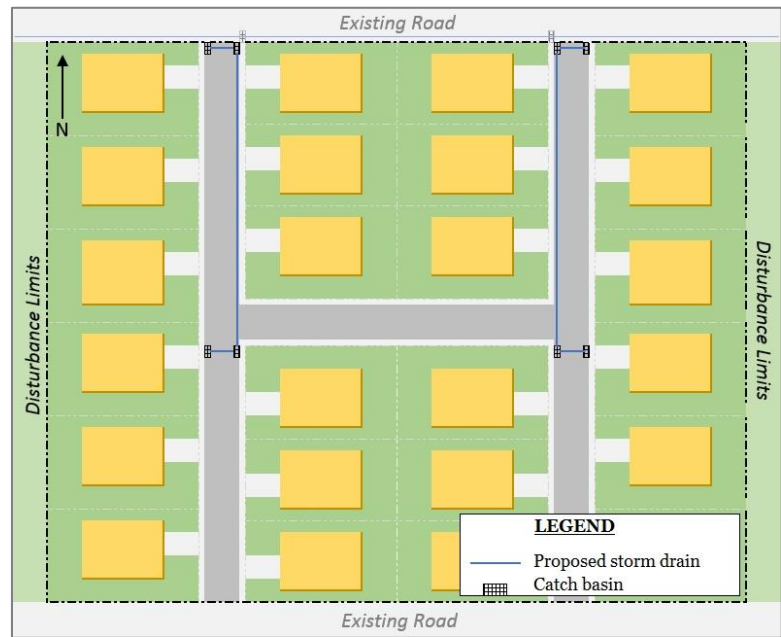

Figure 14: Proposed residential development.

A 6.61-acre residential development (Figure 14) is proposed. The development includes 24 homes, three new 30-foot wide roads, and sidewalks. The site is graded such that runoff will flow to the north. Catch basins and pipes are proposed as shown to connect to the existing storm drain network that runs east to west on the south side of the existing road north of the development.

With the given plan, the site's imperviousness is 51%. Assuming the jurisdiction of this development determines the volumetric runoff coefficient based on the hydrologic soil group and the site's imperviousness (See [Step 3: Volumetric Runoff Coefficient](#)), R_v is calculated to be 0.38. Using the 90th percentile storm depth of 0.55 inches, the volume retention goal of the site is 5,060 cf.

To manage this volume, the design team decided to implement several LID strategies. First, the total impervious surface was reduced by narrowing all roads by 10 feet, which was the minimum roadway width per city guidelines. This resulted in a reduction of impervious area by 0.28 acres, which reduced the site's total imperviousness to 48%. The volume retention goal was recalculated to be 4,680 cf.

To retain the 4,680 cf, rain gardens, bioswales, pervious surfaces, and a dry well were strategically placed to capture the volume retention goal (Figure 15).

Revised LID Design

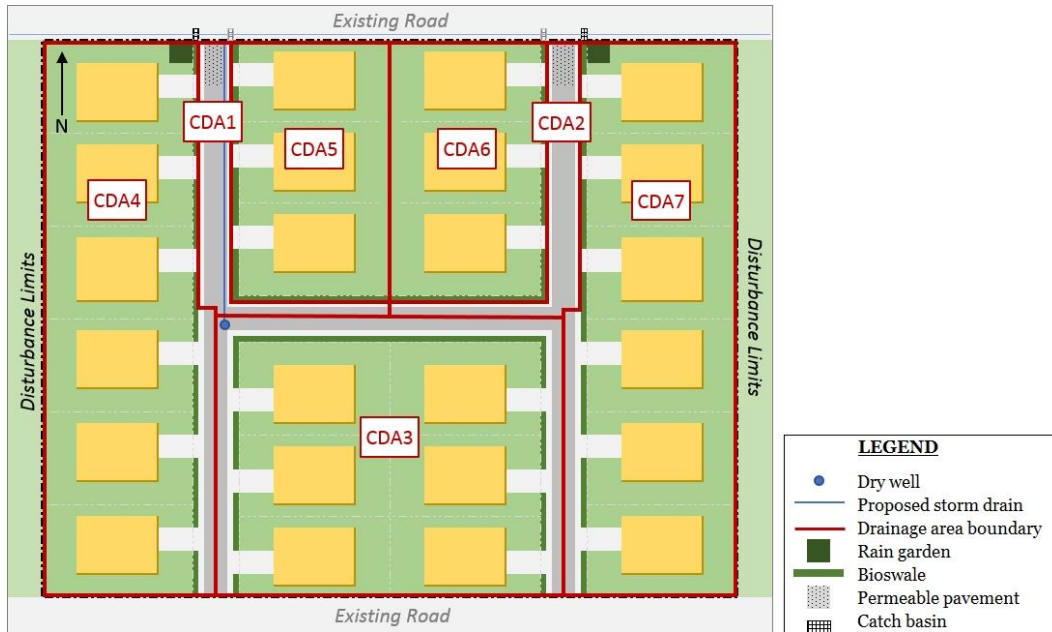

Figure 15: LID approach to residential development.

Contributing Drainage Area	LID BMP Type	Water Quality Volume, WQV (cf)	Runoff Captured (cf)	Percent of WQV Captured	Equivalent Storage Depth (in)	Notes
CDA1	Permeable Pavement	349	349	100%	6	-
CDA2	Permeable Pavement	349	349	100%	6	-
CDA3	Bioswale/Dry Well	1251	937* (bioswale) 565 (dry well)	100%	16 (bioswale)	6 ft x 20 ft dry well
CDA4	Bioswale/Rain Garden	963	238* (bioswale) 726 (rain garden)	100%	6 (bioswale) 24 (rain garden)	-
CDA5	Bioswale	418	527*	100%	18	-
CDA6	Bioswale	418	527*	100%	18	-
CDA7	Bioswale/Rain Garden	963	238* (bioswale) 726 (rain garden)	100%	6 (bioswale) 24 (rain garden)	-
Total		4713	5183	100%		

*33% of water quality volume is assumed to infiltrate into bioswales. See [Volume Reduction](#) for further discussion on swale infiltration.

By narrowing the roads and introducing LID BMPs, the design team was able to capture 100% of the project's volume retention goal. This approach has also reduced the number of catch basins and linear feet of pipe required for the storm drain network (provided flood control consideration has also been incorporated into the design).

Commercial LID

Commercial Development

Development size: 1.18 ac

Imperviousness: 100%

Volumetric runoff coefficient: 0.89

90th percentile storm depth: 0.55 in

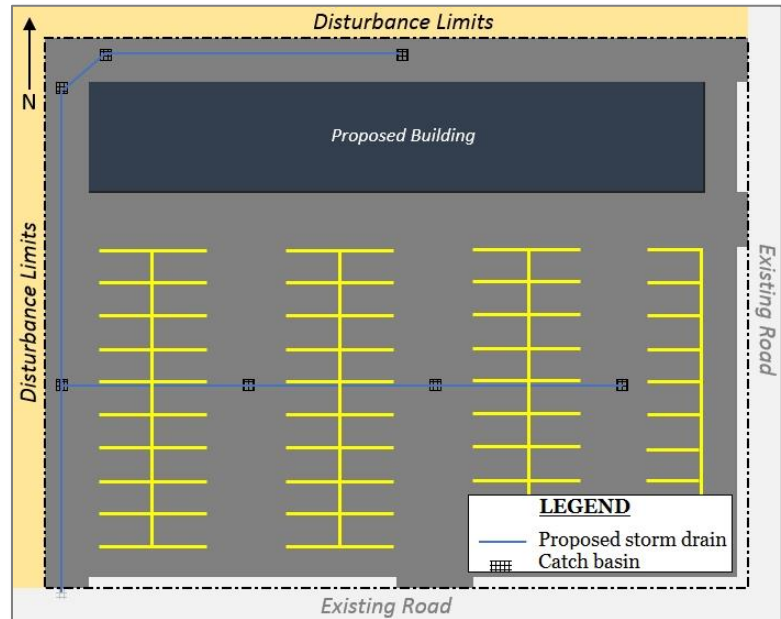

Figure 16: Proposed commercial development.

A 1.18-acre commercial development (Figure 16) is proposed. The development includes a 0.21 acre building and 0.97 acres of parking and sidewalk. A storm drain network has been proposed such that flows will be conveyed to a catch basin at the southwest corner of the site.

With the given plan, the site's imperviousness is 100%. Assuming the jurisdiction of this development adopted the Reese method of determining the runoff coefficient due its applicability for urban development, R_v is calculated to be 0.89 (see [Step 3: Volumetric Runoff Coefficient](#)). Using the 90th percentile storm depth of 0.55 inches, the volume retention goal of the site is 2,088 cf.

To manage this volume, the design team decided to implement three LID features: bioretention areas within the parking lot, and permeable pavement and a bioswale behind the building that will capture runoff from the roof via down drains that were previously designed to discharge into a concrete ditch (Figure 17). Inclusion of these features results in a reduction of impervious area by 0.06 acres, which reduced the site's total imperviousness to 94%. The volume retention goal was recalculated to be 1,959 cf.

The LID features proposed will capture the volume retention goal.

Revised LID Design

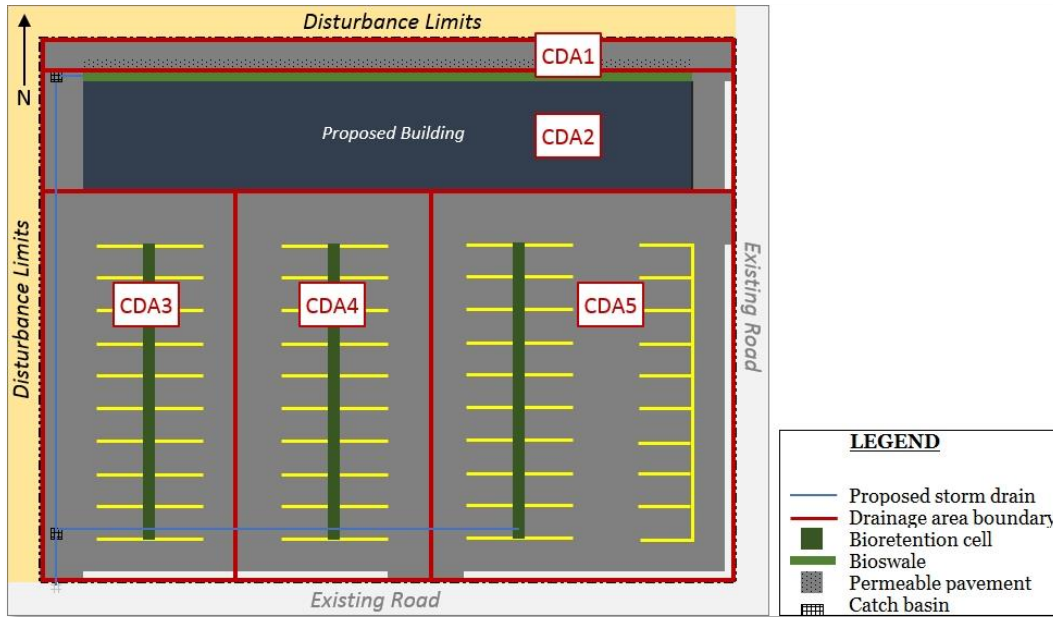

Figure 17: LID approach to commercial development.

Contributing Drainage Area	LID BMP Type	Water Quality Volume, WQV (cf)	Runoff Captured (cf)	Percent of WQV Captured	Equivalent Storage Depth (in)	Notes
CDA1	Permeable Pavement	119	125	100%	6	1 ft width
CDA2	Bioswale	420	440*	100%	16	4 ft width
CDA3	Bioretention Cell	400	432	100%	12	4 ft width
CDA4	Bioretention Cell	400	432	100%	12	4 ft width
CDA5	Bioretention Cell	620	648	100%	18	4 ft width
Total		1959	2077	100%		

*33% of water quality volume assumed to infiltrate into bioswales. See [Volume Reduction](#) for further discussion on swale infiltration.

By using an LID approach, the design team was able to reduce the volume retention requirement and capture 100% of the project’s volume retention goal. Some of the pipe behind the commercial building was replaced with conveyance through the bioswale. Flood control considerations should also be considered for final design.

Industrial LID

Industrial Development

Development Size: 2.64 ac

Imperviousness: 94%

Volumetric runoff coefficient: 0.83

90th percentile storm depth: 0.55 in

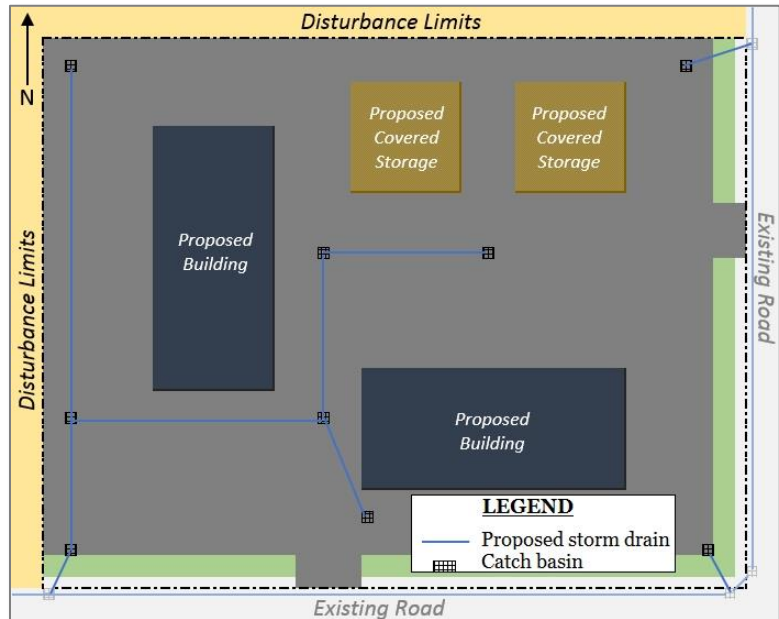

Figure 18: Proposed industrial development.

A 2.64-acre industrial development (*Figure 18*) is proposed. Two new buildings and two covered storage areas are also proposed. The current site will have 0.32 acres of pervious area adjacent to the new sidewalk. There are three connection points to the storm drain network.

With the given plan, the site's imperviousness is 94%. Assuming the jurisdiction of this development adopted the Reese method of determining the runoff coefficient due its applicability for urban development, R_v is calculated to be 0.83 (see *Step 3: Volumetric Runoff Coefficient*). Using the 90th percentile storm depth of 0.55 inches, the volume retention goal of the site is 4,400 cf.

Upon reevaluating the design of the site and subsurface site conditions, two LID features were determined to be appropriate: two infiltration basins and two infiltration trenches (*Figure 19*). Altering the grading design created four contributing drainage areas to the basins and trenches which have overflow connections to the existing catch basins. Pervious areas were also increased. Inclusion of these features results in a reduction of impervious area by 0.18 acres, which reduced the site's total imperviousness to 87%. The volume retention goal was recalculated to be 4,066 cf.

The LID features proposed will capture the volume retention goal.

Revised LID Design

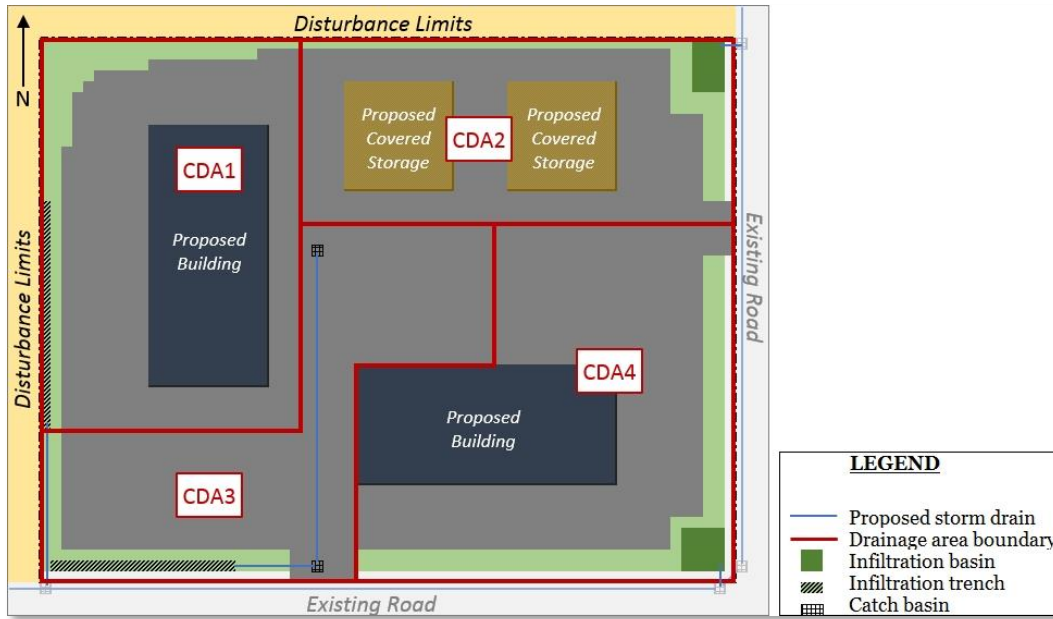

Figure 19: LID approach to industrial development.

Contributing Drainage Area	LID BMP Type	Water Quality Volume, WQV (cf)	Runoff Captured (cf)	Percent of WQV Captured	Equivalent Storage Depth (in)	Notes
CDA1	Infiltration Trench	1073	1073	100%	18	4 ft width
CDA2	Infiltration Basin	871	871	100%	-	Infiltration rate = 2 in/hr Safety factor = 1.33 Drawdown time = 24 hrs Footprint = 230 sf
CDA3	Infiltration Trench	881	881	100%	18	4 ft width
CDA4	Infiltration Basin	1242	1053	85%	-	Infiltration rate = 2 in/hr Safety factor = 1.33 Drawdown time = 24 hrs Footprint = 350 sf
Total		4066	3878	95%		

Due to utility conflicts at the southeast corner of this site, the infiltration basin within CDA4 was not able to be sized for the full project volume retention goal. This is still an acceptable implementation of the 90th percentile retention requirement because retention of 100% of the 90th percentile volume was not possible. LID practices were still successful at this site such as the removal of pipe. Additional water quality measures appropriate for an industrial site such as an oil/water separator are not shown in this example but must be used if necessary. Flood control considerations should be considered for final design.

Local Case Studies

Preface to Case Studies

The following case studies are examples of LID features that were designed with the purpose of collecting urban storm water. They are significant because they demonstrate that within Utah's semiarid climate, bioretention and LID approaches can be successfully implemented. Two of the sites are within Salt Lake County and one is in Grand County.

The sites discussed are:

➤ **Bioretention Area at Mountview Park in Cottonwood Heights**

A bioretention area within a large park captures runoff from parking lots within the park and from a nearby residential area.

➤ **Various LID BMPs at the Sandy City Public Works facility**

Rain gardens, bioswales, vegetated swales, concrete pavers, and permeable asphalt detain and treat runoff from a public works facility.

➤ **Permaculture Garden at Utah State University Moab**

As part of a landscaping renovation at the campus, impervious areas are converted to infiltrating swales and increased pervious surfaces that sustains various plant life.

Note that each of these projects was designed and constructed prior to adoption of the 90th percentile storm water retention requirement. As part of the evaluation of these sites, calculations using methods from the previous section were performed to determine whether the sites would be able to successfully retain the 90th percentile storm depth for the BMPs' drainage areas. The bioretention area at Mountview is undersized for the 90th percentile storm depth. The BMPs at the Sandy City Public Works were designed with the 90th percentile storm volume in mind and four of the nine BMPs were able to be sized for the full water quality volume. Approximate calculations for the 90th percentile storm volume for the Utah State University Moab site were also made.

Bioretention

Mountview Park – Cottonwood Heights

Location: 40.6274°, -111.8449°

Contributing Drainage Area: 18.86 ac

Imperviousness: 65% (approx.)

Bioretention Footprint: 2,470 sf

Soil Type: A (Web Soil Survey)



Figure 20: Bioretention area at Mountview Park.

This bioretention area is one of two constructed by The University of Utah for research purposes in the Spring of 2012 to determine if bioretention is a feasible option in Utah’s semiarid climate (Heiberger, 2013). The bioretention area at Mountview Park remains intact (*Figure 20*); however, the other bioretention site that was constructed on The University of Utah campus has been removed.

The bioretention area is approximately 2,470 sf and has a depth of 4 ft. There are two layers within the bioretention area: the top layer is 2 feet of native backfill soil; the bottom layer is 2 feet of a subsurface reservoir layer composed of Utelite 3/4” medium grade aggregate with a porosity of 53%. Utelite aggregate was selected due to its filtering and planting applications. The porosity of the top layer is 0.25, resulting in a storage capacity of 1,235 cf. The reservoir layer allows for storage of up to 2,620 cubic feet. The total storage capacity is 3,853 cf.

The nearest rain gage with reliable historical data is the Cottonwood Weir rain gage. Its 90th percentile storm depth is 0.86 inches. The drainage area’s total imperviousness is approximately 65%. The runoff coefficient was determined to be 0.57. The water quality volume for this drainage area would be 33,553 cf. which means that the existing bioretention area is undersized for the water quality volume.

Location: 40.5924, -111.9091

Contributing Drainage Area: 7.98 ac

Imperviousness: 93.9%

Soil Types: C & D (Web Soil Survey)

90th Percentile Storm Depth: 0.77 in



Figure 21: Proposed rain garden location.

In the winter of 2017, 60% of the Sandy City Public Works facility was destroyed by a large fire. Sandy City decided to do a full redesign and take a multi-phased approach to rebuilding the entire site. Construction is currently ongoing ([Figure 21](#)).

An LID approach to the site was incorporated into the design and several LID features such as bioswales, rain gardens, and bioretention cells were designed. The Granato method of determining the runoff coefficient ($R_v = 1.14i - 0.371$ when $i \geq 55\%$) was used (Taylor & Barrett, 2014) due to the heavy transportation use at a public works site. The project's total volume retention goal was 15,600 cf. Due to various infeasibilities and to maintain the functional purpose of the site, it was not possible for the proposed BMPs to capture the full retention volume. Some drainage areas within the site were unable to retain or treat any storm water.

Shallow groundwater and poor soils limited infiltration opportunities, and it was decided that all BMP areas would have impermeable liners and underdrain systems. For this reason, all BMPs except for the bioswales were designed as detention devices that provided treatment of runoff instead of retaining it onsite. Outlet structures connecting to the storm drain network were designed to release within an acceptable drawdown time. Treatment at the various BMPs was accomplished through a combination of settling, filtration through vegetation, and bioretention through the BMPs' soil layers. Some retention will be accomplished through the bioswales and could be quantified through monitoring.

A full list of the site's BMPs and a few characteristics of each are given in [Table 8](#) below.

Table 8: LID BMP characteristics designed for the Sandy City Public Works facility.

LID BMP Type	Subsurface Sections	Underdrain	Drainage Area (ac)	WQV (cf)	BMP's Treated Volume (cf)
Rain Garden 1 (lined)	Engineered Soil Coarse Sand Pea Gravel Open Graded Stone	Yes	0.34	737	737
Bioswale 1	Engineered Soil	Yes	0.07	141	27
Bioswale 2	Engineered Soil	Yes	1.23	2309	1469
Rain Garden 2 (lined)	Engineered Soil Coarse Sand Pea Gravel Open Graded Stone	Yes	0.15	280	280
Bioswale 3	Engineered Soil	Yes	0.42	800	366
Rain Garden 3 (lined)	Engineered Soil Coarse Sand Pea Gravel Open Graded Stone	Yes	0.41	885	541
Vegetated Swale	Native backfill	No	0.65	1291	140
Concrete Pavers	AASHTO No. 8 AASHTO No. 57 Drain Rock	Yes	0.13	55	55
Permeable Asphalt	AASHTO No. 8 AASHTO No. 57	Yes	0.13	55	55
Total Volume (cf)				6553	3670

Four of the nine BMPs were able to be sized for their water quality volume. Treatment was provided for 56% of the total water quality volume of all BMPs. Although the volume retention goal for the entire site was 15,600 cf and all drainage areas were evaluated for their retention potential, many of the drainage areas were deemed to be infeasible for various reasons. Lack of available open space, constraints imposed by the downstream storm drain network, and groundwater restricted five of the BMPs from being able to be sized for the full water quality volume. This site would meet the 90th percentile requirement by retaining runoff to the maximum extent practicable.



Figure 22: Construction progress of permaculture garden.

Location: 38.5700°, -109.5526°

Soil Type: C

In 2014, as part of a campus-wide landscaping redesign, it was decided that portions of the parking areas of Utah State University Moab would undergo a renovation to capture rainfall and create a thriving, productive micro-riparian area. With the removal of a few parking spaces and the conversion of previously unused impervious areas, two permaculture gardens were created that now support vegetation and are aesthetically pleasing areas that benefits the public while retaining rainfall that is reintroduced to the soil instead of conveying directly to catch basins. Each garden contains bioretention systems and bioswales (Figure 22) that collect runoff from the adjacent parking lots and down drains from nearby buildings.

Although the permaculture garden was not specifically designed for targeted pollutants, it is worth noting that the garden is located just over one mile away from the Colorado River at the confluence of Mill Creek and Pack Creek. Both creeks are listed for 303(d) impairments including dissolved oxygen, E. coli, dissolved selenium, temperature and total dissolved solids. A monitoring program would reveal the effectiveness of the bioretention and bioswales at removing these pollutants.

The nearest rain gage with a reliable historical record is Arches National Park HQS, which has a 90th percentile storm depth of 0.53 inches. With an estimated contributing drainage area of 1.0 acre and a runoff coefficient determined to be 0.89, the volume retention goal for the permaculture garden would be 1,710 cf.

Additional Local LID Implementation

Daybreak, South Jordan

Daybreak is a mixed-use development located in South Jordan, Utah in the southwest corner of Salt Lake County. The area for the development is planned to contain more than 20,000 residential units.

A variety of techniques were used to mitigate the effects of urbanization on storm water runoff quality. Among the LID techniques used in the community are bioswales, dry wells, constructed wetlands, infiltration trenches, infiltration basins, and detention basins. The community also stipulates that 40% of residential lots and 68% of common open spaces consist of native, drought resistant plants. This strategy is designed to be able to retain the 100-year storm event.

Researchers conducted a water quality monitoring study on the development to determine the effectiveness of the green infrastructure design. One sub-watershed utilized a series of bioswales while the other sub-watershed deployed traditional storm water management techniques. Several constituents were monitored for water quality including nitrogen, phosphorus, suspended solids, and heavy metals. The sub-watershed with bioswales showed significantly reduced runoff volumes as well as large reductions in constituent and heavy metal concentrations when compared to the traditional storm water sub-watershed. A promising finding of the study was that first flush concentrations of copper were reduced, which is significant due to its removal difficulty and the proximity of copper mines in the area. Reductions of other metals during the first flush are listed below. (Yang, Li, Wall, Blackmore, & Wang, 2015)

Total suspended solids, TSS: 92% reduction

Total Nitrogen, TN: 87% reduction

Total Phosphorus, TP: 92% reduction

Zinc, Zn: 96% reduction

Lead, Pb: 96% reduction

Copper, Cu: 82% reduction

Utah State University Research Sites

Utah State University is currently conducting research on the effectiveness of LID techniques on storm water pollutant removal and nutrient uptake. Several LID techniques are being monitored including bioswales, planter boxes, dry wells, bioretention, vegetated filter strips, and membrane roofs at two sites in Logan and one site in Salt Lake City (Dupont, McLean, Peralta, Null, & Jackson-Smith, 2017). The following pollutants are being monitored:

Total Nitrogen, TN	Dissolved Organic Carbon, DOC	Nickel, Ni
Total Dissolved Nitrogen, TDN	Electrical Conductivity, EC	Copper, Cu
Total Phosphorus, TP	pH	Zinc, Zn
Total Dissolved Phosphorus, TDP	Aluminum, Al	Arsenic, As
Nitrate, NO ₃ -N	Chromium, Cr	Cadmium, Cd
Ammonia, NH ₃ -N	Iron, Fe	Lead, Pb

A summary of whether the monitored constituent levels decreased (D) or increased (I) is provided in [Table 9](#). Reasons for the increases in pollutant concentrations are uncertain and are currently being investigated. Of particular concern to the researchers is the mobilization of arsenic, although levels are still significantly lower than drinking water standards. In general, the use of organic matter and fertilizer to establish a BMP's vegetation

is a typical reason for increases in nitrogen and phosphorus concentrations. BMP sites that are experiencing increases in pollutant concentrations should be inspected or further analyzed to eliminate the introduction of pollutants.

Site 1: Bioswale (Logan). Lysimeter measurements taken at depths of 6 inches and 24 inches depths.

Site 2: Bioswale (Logan). Lysimeter measurements taken at depths of 12 inches and 20 inches.

Site 3: Media Filter Layer below Bioretention Cell (Salt Lake City).

Site 4: Dry Well (Logan).

Site 5: Vegetated Parking Strip (Logan).

Table 9: Summary of monitored constituents at five sites.

Monitored Constituent	Site 1	Site 2	Site 3		Site 4	Site 5	
			UteLite Expanded Shale	Pea Gravel		4 ft Sump Sample	6 ft Sump Sample
TN	I	D	D	D	D	I	I
TDN	I	I	D	I	D	D	NC
TP	I	I	NC	NC	D	D	D
TDP	I	I	D	I	D	I	D
NO3-N	D	D	I	I	D	I	D
NH3-N	D	I	D	D	D	I	I
DOC	NM	NM	D	D	D	I	D
EC	I	I	I	I	D	D	D
pH	I	I	I	I	I	D	NC
Al	NM	D	I	I	D	D	I
Cr	NM	D	I	I	D	I	D
Fe	NM	D	I	I	D	I	I
Ni	NM	I	I	I	D	I	I
Cu	NM	D	I	D	D	I	D
Zn	NM	I	D	D	D	I	D
As	NM	I	I	I	D	I	D
Cd	NM	I	I	I	D	D	D
Pb	NM	D	D	I	D	I	D

D = decrease; I = increase; NC = no change; NM = not monitored

Green Meadows, Logan

The Green Meadows subdivision in Logan, Utah is one of Utah State University’s research sites. The subdivision is a relatively new settlement with houses first being constructed in the early 2000s. The western end of the subdivision borders the Logan River which is in the Bear River watershed. A water quality management plan was established for the watershed in 1995 and found that the Logan River had relatively good water quality. As of 2016 it was listed on the 303d report by the Utah DWQ as having impairment for total phosphorus with a TMDL approved by the EPA.

Utah State University used the subdivision for a case study on the effectiveness of vegetative species within bioretention cells. The study focused on biomass production and water quality improvement to measure the effectiveness of the vegetation. Laboratory tests were conducted with simulated frequency and duration rainfall events to measure biomass production and pollutant removal. Field tests were conducted at the site to generate water quality improvement effectiveness data. Citric acid was added at the field site to simulate a possible increase in nutrient and metal uptake.

The USU study found that common reed and sedges were optimal plants for the area to improve storm water quality. The field site showed significant retention and infiltration capacities throughout the study and 100% pollutant removal from storm water runoff. Maximum nutrient and metal removal was shown to be possible at the site if there was no discharge from the bioretention cells. In tests with added citric acid, metal solubility was increased in the runoff but no enhanced metal uptake was observed. (Dupont & McLean, Optimizing Stormwater BMP Performance, 2018)

Northern Utah Runoff Coefficients

Additional research at Utah State University evaluated runoff coefficients at four sites in northern Utah. Monitoring of dozens of rain events took place from 2015 to 2017. Runoff coefficients were derived by dividing the cumulative rainfall by the cumulative runoff values for the rain events at each site. The sites are identified as 1400 N, 1300 N, 1000 N, and 800 N.

Data from the sites was statistically analyzed to determine relationships between the observed runoff coefficients and rain depth, storm intensity, and storm duration. Statistical significance (p values) and R squared values (the strength of the relationship between the runoff coefficient and the other parameters) were calculated. At the 1400 N site and 1300 N sites, the relationships between the runoff coefficient and all three parameters were found to be insignificant. The 1000 N site showed no statistical significance between the runoff coefficient and the storm intensity but did show significance between the runoff coefficient and storm duration. The 800 N site showed statistical significance between the runoff coefficient and both the storm duration and the storm intensity. Although general trends do come out in the data (increased rain depth results in higher runoff coefficients) R squared values were generally low due to the scattered nature of the data (Velásquez, 2018).

The range of imperviousness from these four sites is limited. The 1400 N and 1300 N sites were approximately 90% impervious and the 1000 N and 800 N sites were both approximately 65%. Jurisdictions will encounter a wider variation of imperviousness for their developments. Developing regression equations for runoff coefficients based on the 90th percentile storm depth that use the imperviousness as the control variable may be simpler to apply jurisdiction-wide to projects since imperviousness will be the parameter with the greatest variability. See [Step 3: Volumetric Runoff Coefficient](#) for more information on runoff coefficient equations that may be appropriate for use on a jurisdictional level.

Appendix A 90th Percentile Storm Depths

STATION	NAME	LATITUDE	LONGITUDE	ELEVATION (FT)	90TH PERCENTILE DEPTH (IN)
USC00420074	ALTAMONT, UT US	40.3670	-110.2986	6456	0.53
USC00420086	ALTON, UT US	37.4402	-112.4819	7098	0.81
USC00420168	ANGLE, UT US	38.2486	-111.9608	6410	0.53
USC00420336	ARCHES NATIONAL PARK HQS, UT US	38.6163	-109.6191	4093	0.56
USC00420527	BEAVER CANYON POWER HOUSE, UT US	38.2682	-112.4818	7275	0.74
USS0011J46S	BEAVER DIVIDE, UT US	40.6100	-111.1000	8280	0.70
USS0011H08S	BEN LOMOND PEAK, UT US	41.3800	-111.9400	8000	1.50
USS0012L07S	BIG FLAT, UT US	38.3000	-112.3600	10349	0.90
USC00420688	BIG WATER, UT US	37.0769	-111.6638	4100	0.59
USC00420738	BLANDING, UT US	37.6130	-109.4847	6032	0.66
USC00420788	BLUFF, UT US	37.2824	-109.5575	4319	0.54
USC00420849	BOULDER, UT US	37.9050	-111.4200	6650	0.65
USC00420819	BOUNTIFUL BENCH, UT US	40.8910	-111.8504	4950	0.86
USC00420928	BRIGHAM CITY WASTE PLANT, UT US	41.5239	-112.0436	4230	0.70
USS0010J30S	BROWN DUCK, UT US	40.5800	-110.5900	10600	0.80
USC00421008	BRYCE CANYON NATIONAL PARK HQRS, UT US	37.6405	-112.1701	7915	0.82
USS0011K31S	BUCK FLAT, UT US	39.1300	-111.4400	9430	0.70
USS0011H37S	BUG LAKE, UT US	41.6800	-111.4200	7950	0.80
USC00421163	CANYONLANDS THE NECK, UT US	38.4600	-109.8213	5871	0.58
USC00421168	CANYONLANDS THE NEEDLES, UT US	38.1678	-109.7597	4906	0.55
USC00421171	CAPITOL REEF NATIONAL PARK, UT US	38.2917	-111.2622	5500	0.65
USC00421260	CEDAR CITY 5 E, UT US	37.6563	-112.9919	6450	0.78
USW00093129	CEDAR CITY AIRPORT, UT US	37.7086	-113.0944	5586	0.61
USC00421308	CEDAR POINT, UT US	37.7158	-109.0827	6760	0.69
USC00421446	CITY CREEK WATER PLANT, UT US	40.8397	-111.8313	5330	0.91
USC00421759	COTTONWOOD WEIR, UT US	40.6189	-111.7836	4986	0.86
USC00421918	CUTLER DAM, UT US	41.8328	-112.0558	4290	0.67
USC00422057	DEER CREEK DAM, UT US	40.4044	-111.5289	5270	0.80
USW00023162	DELTA, UT US	39.3374	-112.5856	4620	0.47
USC00422101	DESERET, UT US	39.2872	-112.6519	4590	0.49
USS0011H55S	DRY BREAD POND, UT US	41.4100	-111.5400	8350	0.70
USC00422253	DUCHESNE, UT US	40.1703	-110.3978	5551	0.55
USC00422385	ECHO DAM, UT US	40.9655	-111.4336	5470	0.57
USC00422578	EPHRAIM, UT US	39.3583	-111.5991	5498	0.54
USC00422592	ESCALANTE, UT US	37.7686	-111.5977	5810	0.67
USC00422607	ESKDALE, UT US	39.1077	-113.9533	4980	0.54
USC00422828	FILLMORE, UT US	38.9663	-112.3279	5120	0.66
USC00422864	FLAMING GORGE, UT US	40.9316	-109.4116	6244	0.62
USC00423012	FREMONT INDIAN S.P., UT US	38.5777	-112.3347	5920	0.60

STATION	NAME	LATITUDE	LONGITUDE	ELEVATION (FT)	90TH PERCENTILE DEPTH (IN)
USW00023170	HANKSVILLE, UT US	38.3692	-110.7145	43010	0.51
USC00423600	HANS FLAT RANGER STATION, UT US	38.2553	-110.1800	6600	0.58
USC00424100	HOVENWEEP NATIONAL MONUMENT, UT US	37.3858	-109.0750	5240	0.63
USC00424342	JENSEN, UT US	40.3610	-109.3463	4736	0.55
USC00424467	KAMAS, UT US	40.6438	-111.2822	6481	0.62
USC00424755	KODACHROME BASIN PARK, UT US	37.5141	-111.9883	5805	0.70
USC00424947	LA SAL 1 SW, UT US	38.3013	-109.2664	6787	0.61
USC00424968	LA VERKIN, UT US	37.2009	-113.2685	3194	0.74
USC00424856	LAKETOWN, UT US	41.8252	-111.3206	5980	0.63
USC00425065	LEVAN, UT US	39.5608	-111.8652	5298	0.58
USC00425138	LITTLE SAHARA RECREATION AREA, UT US	39.7268	-112.3069	5230	0.68
USC00425194	LOGAN 5 SW EXPERIMENTAL FARM, UT US	41.6661	-111.8913	4488	0.66
USC00425182	LOGAN RADIO KVNU, UT US	41.7350	-111.8564	4475	0.62
USC00425186	LOGAN UTAH ST U, UT US	41.7456	-111.8033	4790	0.67
USC00425252	LYTLE RANCH, UT US	37.1430	-114.0213	2787	0.84
USC00425402	MANTI, UT US	39.2583	-111.6307	5740	0.55
USC00425582	MEXICAN HAT, UT US	37.1497	-109.8675	4109	0.57
USC00425654	MILFORD, UT US	38.4017	-113.0162	5009	0.61
USC00425733	MOAB, UT US	38.5744	-109.5458	4053	0.55
USC00425826	MORGAN, UT US	41.0574	-111.6895	5100	0.62
USC00425837	MORONI, UT US	39.5266	-111.5872	5560	0.57
USC00425892	MOUNTAIN DELL DAM, UT US	40.7485	-111.7232	5420	0.77
USC00425969	MYTON, UT US	40.1941	-110.0616	5083	0.55
USC00426053	NATURAL BRIDGES N.M., UT US	37.6094	-109.9772	6508	0.65
USC00426123	NEOLA, UT US	40.4178	-110.0511	5950	0.59
USC00426357	OAK CITY, UT US	39.3758	-112.3341	5120	0.67
USC00426869	PINEVIEW DAM, UT US	41.2577	-111.8377	4940	0.94
USC00427260	RICHFIELD RADIO KSVC, UT US	38.7619	-112.0775	5300	0.50
USC00427271	RICHMOND, UT US	41.9063	-111.8100	4680	0.67
USC00427395	ROOSEVELT RADIO, UT US	40.2878	-109.9586	5014	0.50
USC00427559	SALINA 24 E, UT US	38.9129	-111.4165	7560	0.55
USW00024127	SALT LAKE CITY INTERNATIONAL AIRPORT, UT US	40.7781	-111.9694	4225	0.59
USC00427686	SANTAQUIN CHLORINATOR, UT US	39.9578	-111.7794	5160	0.75
USC00427714	SCIPIO, UT US	39.2454	-112.1066	5314	0.60
USC00427909	SNAKE CREEK POWERHOUSE, UT US	40.5452	-111.5041	6010	0.68
USC00428119	SPANISH FORK POWER HOUSE, UT US	40.0800	-111.6046	4720	0.75
USC00427516	ST. GEORGE, UT US	37.1190	-113.6068	2857	0.69

STATION	NAME	LATITUDE	LONGITUDE	ELEVATION (FT)	90TH PERCENTILE DEPTH (IN)
USC00428456	SUMMIT, UT US	37.8008	-112.9328	6017	0.68
USC00428771	TOOELE, UT US	40.5352	-112.3218	4944	0.73
USC00429165	WANSHIP DAM, UT US	40.7908	-111.4077	5940	0.58
USC00429346	WEBER BASIN PUMP PLANT 3, UT US	41.1091	-111.9125	4900	0.91
USC00429368	WELLINGTON 3 E, UT US	39.5447	-110.6861	5400	0.58
USC00429595	WOODRUFF, UT US	41.5250	-111.1494	6315	0.57
USC00429717	ZION NATIONAL PARK, UT US	37.2091	-112.9814	4038	0.81

Appendix B Storm Water Quality Report Template

Storm Water Quality Report – Template

This is an example of how the suggested report template is completed. Text highlighted in yellow is project specific information. A blank word document of this template can be found here:

<https://documents.deq.utah.gov/water-quality/stormwater/DWQ-2018-013750.docx>

Date: 9/1/2019

Project Name: Garden Valley Condominiums

Project ID: 999999

Design Engineer: John Doe, PE

Is the project within a watershed that is 303(d) listed? Yes

If yes:

Name of receiving water(s): Little Cottonwood Creek-2

Listed Impairment(s): pH; Cadmium, Dissolved; Copper, Dissolved

Does the watershed have an approved TMDL? Yes

If yes:

Approved TMDL(s): Zinc

I have reviewed the storm water quality design and find this report to be complete, accurate, and current.

Project Manager

[name], Project Manager

Storm Water Coordinator

[name], Designate Storm Water Coordinator

Maintenance

[name], Head of Maintenance

[stamp required at final design phase]

Landscaping

[name], Landscape Architect or Equivalent

Project Information

Type of Project (New Development, Redevelopment): New Development

Area of Land Disturbance (ac): 3.7

Project Impervious Area (ac): 2.9

Project Imperviousness (%): 68

Project Volumetric Runoff Coefficient, R_v: 0.59

90th Storm Depth (in): 0.64

Project 90th Percentile Volume, V_{goal} (cf): 5.110

Subsurface Information

Groundwater

Depth to Groundwater (ft): 17 ft

Historical High Depth to Groundwater if known (ft): 9 ft

Source: Project groundwater monitoring

Groundwater Contamination at Site: None

Soil Information

Infiltration Rate (in/hr): 1.5 in/hr

Hydrologic Soil Group: A

Source: Project geotechnical report

Soil Contamination at Site: None

Drinking Water

Within Drinking Water Source Area Protection: No

Additional Relevant Site Information

[Redacted area]

LID Drainage Areas

Add additional rows as needed.

Contributing Drainage Area	Area (ac)	Impervious Area (ac)	Imperviousness (%)	Volumetric Runoff Coefficient, R_v	Water Quality Volume, WQV (cf)
CDA 1	0.90	0.50	0.56	0.49	1015
CDA 2	0.75	0.45	0.60	0.53	915
CDA 3	0.80	0.80	1.0	0.89	1654
CDA 4	1.25	0.75	0.60	0.53	1526
Total WQV (cf)					5110

LID BMP Design

Add additional rows as needed.

Contributing Drainage Area	LID BMP Type	Water Quality Volume, WQV (cf)	Runoff Retained (cf)	Percent of Runoff Captured (%)
CDA1	Rain Garden	1015	1023	100
CDA 2	Infiltration Basin	915	920	100
CDA 3	Bioretention Cell	1654	1655	100
CDA 4	Bioretention Cell	1526	1600	100
Total Volume Retained (cf)			5198	100

Percent of V_{goal} captured by LID BMPs: 100 %

If 100% of V_{goal} is not captured, document and provide narrative of technical infeasibilities and/or alternate compliance measures below:

Describe additional storm water quality measures incorporated into the site:

Appendix C LID BMP Fact Sheets



Rain Garden

BR-1



Pollutant Removal Effectiveness

Pollutant	Effectiveness
Sediment	High
Nutrients	High
Metals	High
Bacteria	High
Oil/Grease	High

Rain gardens are shallow bioretention areas with engineered or native soils. A variety of plants are used to increase infiltration and nutrient uptake including trees, shrubs, grasses, and other plants suitable for the climate. Rain gardens may be designed with various layers of soil, sand, and aggregate. They may also be designed with the existing soils at the site if the soils are expected to adequately infiltrate, support vegetation, and remove pollutants. They can be topped with a wood or rock mulch, any organic material, or other landscaping features. Performance is increased with high carbon soils. Sand and aggregate layers below the soil layers may provide filtration and storage. Rain gardens are usually well-received by the public for their aesthetic qualities.

Slopes leading to the garden bottom are gentle or steep based on site constraints, such as within urban areas. Ponding depths are typically between 1 to 18 inches. Underdrains and impermeable liners are necessary when subsurface concerns exist such as proximity to a structure, poorly infiltrating soils beneath the cross-section of the garden, or groundwater concerns. When a rain garden must be lined, its volume retention function is eliminated, pollutant removal effectiveness is diminished, and it functions primarily as a detention device; however, it still provides treatment through biofiltration. A bypass mechanism either within the rain garden or upstream of the rain garden should be considered for flood events.

Primary Functions	
Bioretention	Yes
Volume Retention	Yes
Biofiltration	Yes

Design Criteria

Refer to *Design Criteria* in the *Preface to Fact Sheets* for discussion of design criteria parameters.

Parameter	Min. Value	Max. Value	Notes
Depth to Historical High Groundwater	2 ft	No maximum	-
Side Slopes	No minimum	3H:1V	-
Ponding Depth	No minimum	18 in	-
Drawdown Time	12 hours	72 hours	24 to 48 hours preferred. Drawdown time may also depend on local mosquito abatement regulations.
Design Infiltration Rate	0.25 in/hr	6 in/hr	Field testing required for final design. Infiltration rate should be low enough to allow biofiltration processes to occur. During design, infiltration rate, drawdown time, and the soil matrix depth will be directly related.
Freeboard	No minimum	No maximum	Freeboard per jurisdiction standards. For public safety, consider requiring freeboard and a minimum 6-inch embankment when ponding depth is greater than 6 inches.

Calculation Methods

Rain garden design is governed by the water quality volume. The general design steps are:

1. Calculate the water quality volume.
2. Determine the geometry of the rain garden.
3. Based on the rain garden geometry and the porosity of the soil layers, determine the ponding depth and soil matrix depth required to hold the water quality volume.
4. Calculate the drawdown time.
5. Calculate the water quality outlet elevation.

Sample Calculations

Refer to *Calculation Methods* in the *Preface to Fact Sheets* for discussion on the equations used.

A site has 1,500 sf of available open space at the downstream end of a parking lot. The parking lot and an adjacent pervious surface constitute one drainage area that is 0.75 ac in size. The total imperviousness of the drainage area is 0.80. The jurisdiction has a maximum drawdown time of 48 hours and uses a safety factor of 1.5 for water quality design.

Given

Contributing drainage area: 0.75 ac

Imperviousness: 0.80

90th percentile storm depth: 0.60 in

Design infiltration rate: 1.75 in/hr

Determine

The footprint and depth of a rain garden that can retain the water quality volume.

Calculations

Volumetric runoff coefficient, R_V (See *Sample Calculations*)

$$R_V = 0.91i - 0.0204 \text{ (Reese method)}$$

$$R_V = 0.91(0.80) - 0.0204$$

$$R_V = 0.71$$

Water quality volume, WQV (See *Developing the 90th Percentile Volume*)

$$WQV = R_V dA$$

$$WQV = (0.71)(0.60 \text{ in})(0.75 \text{ ac})(43,560 \text{ sf/ac}) / (12 \text{ in/ft})$$

$$WQV = 1,160 \text{ cf}$$

Minimum footprint, A_{\min} (See *Minimum footprint area*)

$$A_{\min} = (12)(\text{Safety Factor})(WQV) / kt$$

$$A_{\min} = (12)(1.50)(1,160 \text{ cf}) / (1.75 \text{ in/hr})(48 \text{ hrs})$$

$$A_{\min} = 250 \text{ sf}$$

The water quality volume will infiltrate into the existing soil in 48 hours if the rain garden bottom is 250 square feet. However, this does not mean that the rain garden bottom is required to be 250 square feet. A larger footprint with a faster drawdown time may be acceptable and reduce the depth required to retain the water quality volume.

A rain garden with a bottom footprint of 1,160 sf, a 12-inch ponding depth will retain the water quality volume. If a safety factor is desired, it should be accounted for by multiplying the water quality volume by the safety factor.

Rain Garden Effectiveness

Effective rain gardens provide an aesthetically pleasing method for retaining and treating storm water. Visiting rain gardens during rain events will reveal if the garden is draining properly. Rain gardens are performing properly if they are retaining their design volume and treating runoff. Creating and following through on maintenance guidelines are critical to ensuring that a rain garden remains functional.

There are many possible indications that a rain garden has failed or is near failure, such as: ponding beyond the design ponding depth during small storm events, drawdown time exceeds design drawdown time, larger than expected sediment buildup within or upstream of the rain garden, irregular settling of the rain garden bottom creating standing water, sloughing of side slopes, excessive and unmaintained vegetation, lack of vegetation, and no maintenance or no record of maintenance. Although this is not an all-inclusive list, being aware of these items will assist in determining what steps need to be taken to remediate a failing rain garden.

Designer Checklist

If the answer to these questions corresponds to a response box that is red, the BMP should either not be used or additional measures need to be taken to address the issue.

	<u>Yes</u>	<u>No</u>
Does groundwater meet the minimum separation requirement?	<input type="checkbox"/>	<input type="checkbox"/>
Is there available right-of-way, property, or easement?	<input type="checkbox"/>	<input type="checkbox"/>
Is the design infiltration rate within acceptable rates?	<input type="checkbox"/>	<input type="checkbox"/>
Is contaminated groundwater present?	<input type="checkbox"/>	<input type="checkbox"/>
Is the drainage area to the rain garden less than 5 acres? (If no, consider an infiltration basin or subdividing to create smaller drainage areas.)	<input type="checkbox"/>	<input type="checkbox"/>
Do utility conflicts make installation of the rain garden technically infeasible?	<input type="checkbox"/>	<input type="checkbox"/>
Do geotechnical conditions exist that would compromise the stability of the rain garden or surrounding structures?	<input type="checkbox"/>	<input type="checkbox"/>
Does the rain garden provide storage for 100% of the water quality volume? (If no, it may still be appropriate to construct the rain garden if it is technically infeasible to capture 100% of the water quality volume.)	<input type="checkbox"/>	<input type="checkbox"/>
Does an overflow outlet structure or bypass mechanism exist?	<input type="checkbox"/>	<input type="checkbox"/>

Vegetation

Refer to [Vegetation Guidance by BMP Type](#).

Installation

Excavation

Rain gardens, like other BMPs whose functionality is dependent on infiltration, will fail if proper care is not taken during excavation and construction. Excavators and heavy machinery should not be used within the rain garden area if infiltration is expected to occur through the rain garden bottom. Additional excavation beyond the rain garden's footprint may be required depending on site conditions to provide soil stability or to be able to tie-in to the surrounding grade.

Activities During Construction

Avoid using heavy machinery within the rain garden footprint during construction as doing so will compact the soils and diminish their infiltrating capabilities. Light machinery and even walking within the rain garden's footprint will also compromise infiltration. Compaction of native soils or backfill below the rain garden subsoils is acceptable if doing so does not prevent infiltration from occurring.

Flows During Construction

Flows during construction should be diverted away from the rain garden to prevent construction site sediment from clogging soils. Scheduling installation of the rain garden shortly after excavation will minimize the impact of unnecessary storm water flows from entering the excavated area. The introduction of unwanted sediment can be prevented by placing fiber rolls or silt fences around the rain garden perimeter during construction.

Additional Guidance

- Require certificates of compliance to verify that construction items meet specification requirements.
- Follow landscaping guidance to ensure that vegetation establishes after installation.

Installation Costs

The following cost items are typically associated with rain garden construction.

- Excavation
- Grading
- Fine grading
- Granular borrow fill
- Landscaping and vegetation
- Top layer
- Engineered soil
- Coarse sand
- Crushed gravel
- Open graded stone
- Geotextile fabric
- Outlet structure or upstream bypass structure (for larger storm events)
- Observation wells
- Curb and gutter
- Impermeable liner (if needed)
- Underdrain system (if needed)
- Irrigation system (if needed)

Maintenance

Refer to *Maintenance* and *Maintenance Costs* in the *Preface to Fact Sheets* for general information related to maintenance of bioretention BMPs.

Maintenance Activities

Inspection	Inspection/Maintenance Frequency	Maintenance Activity	Effort
Inspect for adequate vegetative coverage, and impaired or failing vegetation.	Semiannual (Spring, Fall)	Reseed/replant barren spots. Notify the engineer if failing vegetation persists.	Low
Inspect side slopes for erosion, rilling, and sloughing.	Semiannual (Spring, Fall)	Regrade side slope if sloughing does not impact slope stability. Notify the engineer if side slope stability has been compromised and is affecting the functionality of the basin.	Low
Inspect for trash and debris within basin and at inlet and outlet structures.	Semiannual (Spring, Fall) or as needed	Remove and dispose of trash and debris.	Low
Inspect for large deposits of sediment on basin bottom indicating soil clogging.	Semiannual (Spring, Fall) or as needed	Remove and dispose of built up sediment when buildup causes reduction in size of	Low

Inspection	Inspection/Maintenance Frequency	Maintenance Activity	Effort
		basin or if buildup results in standing water. Notify the engineer in the case of standing water as it may indicate clogging within the basin's soil layers.	
Inspect for standing water within rain garden or within observation well.	Semiannual (Spring, Fall) or as needed	Notify the engineer for further inspection.	Medium
Inspect for failure of additional features such as underdrains or irrigation systems.	Semiannual (Spring, Fall) or as needed	Repair as needed.	Medium

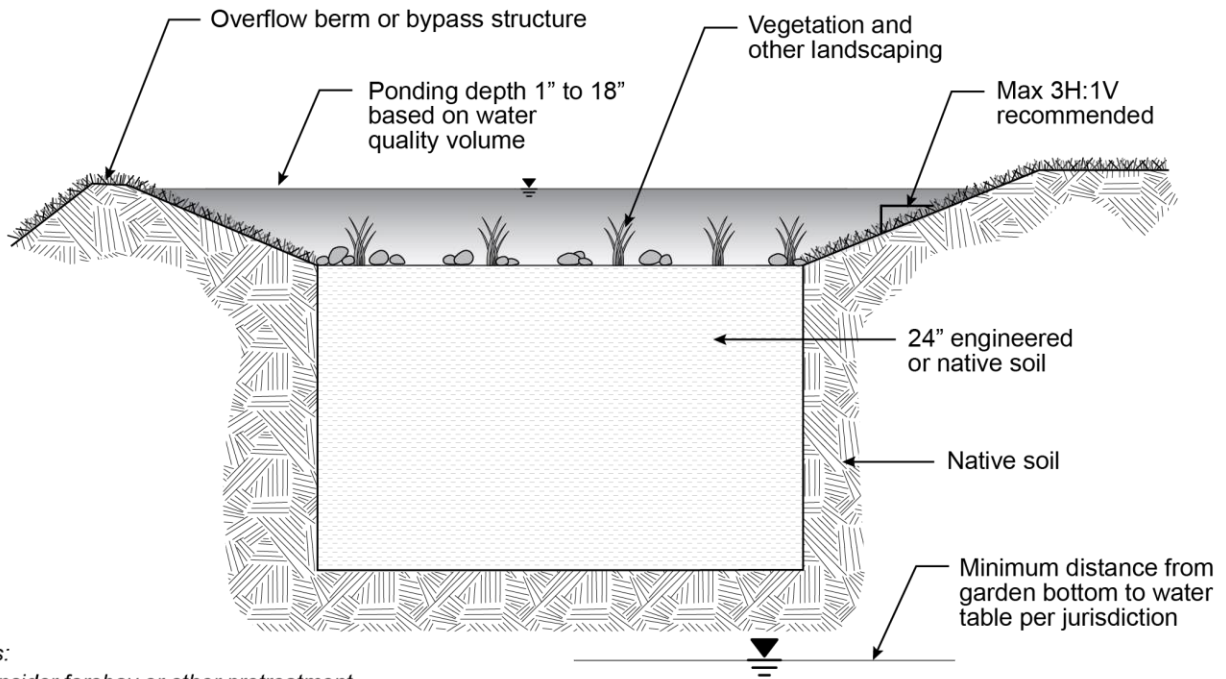

Notes:

- Consider forebay or other pretreatment
- Consider upstream bypass for large storm events

Rain Garden in Native or Engineered Soils

Not to scale

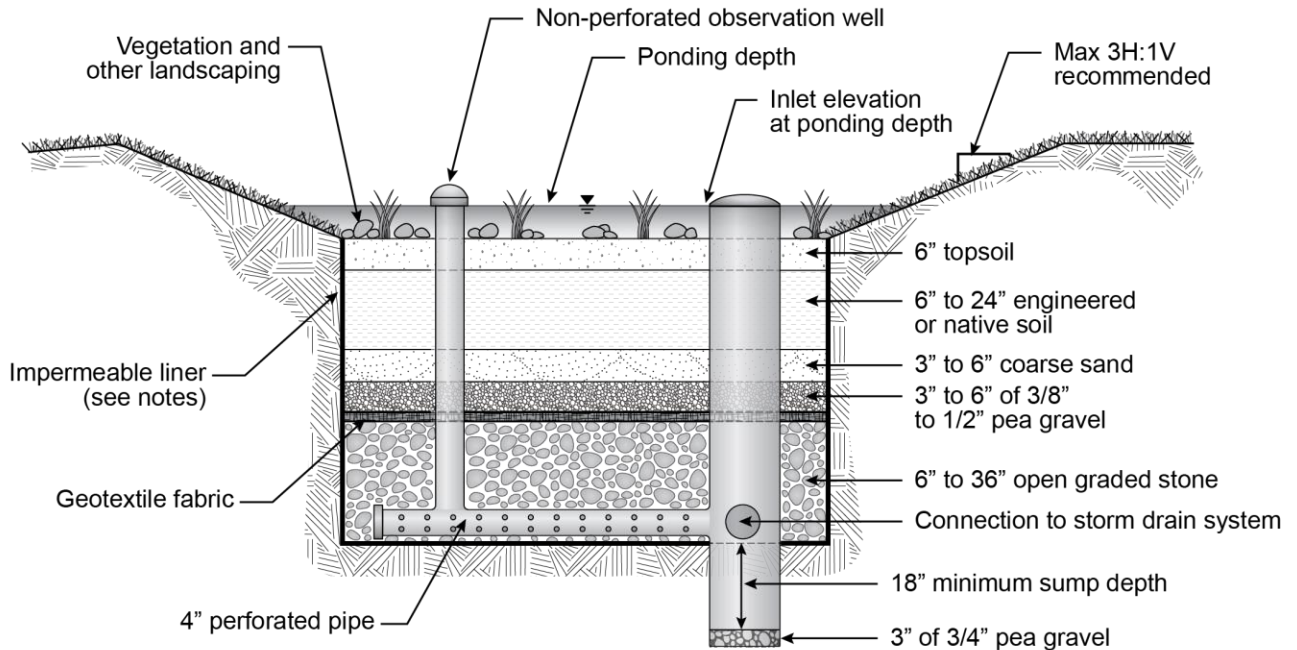

Notes:

- Impermeable liner around all sides and bottom of rain garden if groundwater concerns exist
- Dimensions shown may vary based on site conditions
- Consider forebay or other pretreatment

Rain Garden with Underdrain System

Not to scale



Bioretention Cell

BR-2



Pollutant Removal Effectiveness

Pollutant	Effectiveness
Sediment	High
Nutrients	High
Metals	High
Bacteria	High
Oil/Grease	High

Bioretention cells are shallow bioretention areas with engineered soil. They typically differ from rain gardens by having a delineation such as a curb, wall, or other distinct boundary. Similar to a rain garden, a variety of plants are used to increase infiltration and nutrient uptake including trees, shrubs, grasses, and other plants suitable for the climate. They may be designed with native soils or various layers of soil, sand, and aggregate. They can be topped with a wood or rock mulch, any organic material, or other landscaping features. Performance is increased with high carbon soils. Sand and aggregate layers below the soil layers provide filtration and storage.

Ponding depths are usually between 1 to 18 inches. In areas with high foot traffic, it may be necessary to provide a safety bench of soil within the cell and a minimum side slope leading to the cell bottom. Underdrains and impermeable liners are necessary when subsurface concerns exist such as proximity to a structure, poorly infiltrating soils, or groundwater concerns. When a bioretention cell must be lined, its volume retention function is eliminated, its pollutant removal effectiveness is diminished, and it functions primarily as a detention device; however, it still provides treatment through biofiltration. A bypass mechanism either within the bioretention cell or upstream of the cell should be considered for flood events.

Primary Functions	
Bioretention	Yes
Volume Retention	Yes
Biofiltration	Yes

Design Criteria

Refer to *Design Criteria* in the *Preface to Fact Sheets* for discussion of design criteria parameters.

Parameter	Min. Value	Max. Value	Notes
Depth to Historical High Groundwater	2 ft	No maximum	-
Ponding Depth	No minimum	18 in	-
Drawdown Time	12 hours	72 hours	24 to 48 hours preferred. Drawdown time may also depend on local mosquito abatement regulations.
Design Infiltration Rate	0.25 in/hr	6 in/hr	Field testing required for final design. Infiltration rate should be low enough to allow biofiltration processes to occur. During design, infiltration rate, drawdown time, and the soil matrix depth will be directly related.
Freeboard	No minimum	No maximum	Freeboard per jurisdiction standards. For public safety, consider requiring freeboard and a minimum 6-inch embankment when ponding depth is greater than 6 inches.

Calculation Methods

Bioretention cell design is governed by the water quality volume. The general design steps are:

1. Calculate the water quality volume.
2. Determine the geometry of the bioretention cell.
3. Based on the bioretention cell geometry and the porosity of the soil layers, determine the ponding depth and soil matrix depth required to hold the water quality volume.
4. Calculate the drawdown time.
5. Calculate the water quality outlet elevation.

Sample Calculations

Refer to *Calculation Methods* in the *Preface to Fact Sheets* for discussion on the equations used.

A drainage area within a proposed roadway will be one-third of an acre with 90% imperviousness. It is proposed that three bioretention cells be placed within the drainage area creating three sub-drainage areas. Each sub-drainage area has the same imperviousness and 'A' soils are present.

Given

Contributing drainage area: 0.11 ac

Imperviousness: 0.90

Storm depth: 0.50 in

Design infiltration rate: 1.60 in/hr

Determine

The footprint and depth of the bioretention cells that can retain the water quality volume.

Calculations

Volumetric runoff coefficient, R_V (See *Sample Calculations*)

$$R_{V-A} = 0.84i^{1.302} \text{ (} R_V \text{ based on hydrologic soil group)}$$

$$R_{V-A} = 0.84(0.90)^{1.302}$$

$$R_V = 0.73$$

Water quality volume, WQV (See *Developing the 90th Percentile Volume*)

$$WQV = (0.73)(0.50 \text{ in})(0.11 \text{ ac})(43,560 \text{ sf/ac}) / (12 \text{ in/ft})$$

$$WQV = 150 \text{ cf}$$

Minimum footprint, A_{min} (See *Minimum footprint area*)

$$A_{min} = (12)(1.50)(150 \text{ cf}) / (1.60 \text{ in/hr})(48 \text{ hrs})$$

$$A_{min} = 34 \text{ sf}$$

The water quality volume will infiltrate into the existing soil in 48 hours if the footprint area of all bioretention cells is 34 square feet. However, this does not mean that the bioretention cell footprint is required to be 34 square feet. A larger footprint with a faster drawdown time is acceptable and will reduce the depth required to retain the water quality volume.

If the bioretention cell were to require an engineered soil layer, the design below with a bottom footprint of 200 sf will retain the water quality volume. If a safety factor is desired, it should be accounted for by multiplying the water quality volume by the safety factor.

Layer	Thickness, in	Porosity	Storage Volume, cf
Ponding	3	1.0	50
Top Soil	6	0.25	25
Engineered Soil	8	0.25	33.3
Coarse Sand	3	0.35	17.5
Pea Gravel	3	0.25	17.5
Aggregate Storage	4	0.4	26.7
Total	24 (soil layers)	0.37 (soil layers weighted)	165 (includes ponding)

Bioretention Cell Effectiveness

Effective bioretention cells provide an aesthetically pleasing method for retaining and treating storm water. Inspecting bioretention cells during rain events will reveal if the cell is draining properly. Bioretention cells are performing properly if they are retaining their design volume and treating runoff. Creating and following through on maintenance guidelines are critical to ensuring that a bioretention cell remains functional.

There are many possible indications that a bioretention cell has failed or is near failure, such as: ponding beyond the design ponding depth during small storm events, drawdown time exceeds design drawdown time, larger than expected sediment buildup within or upstream of the cell, excessive and unmaintained vegetation, lack of vegetation, obstructions at the inlet and outlet locations, and no maintenance or no record of maintenance. Although this is not an all-inclusive list, being aware of these items will assist in determining what steps need to be taken to remediate a failing bioretention cell.

Designer Checklist

If the answer to these questions corresponds to a response box that is red, the BMP should either not be used or additional measures need to be taken to address the issue.

	<u>Yes</u>	<u>No</u>
Does groundwater meet the minimum separation requirement?	<input type="checkbox"/>	<input type="checkbox"/>
Is there available right-of-way, property, or easement?	<input type="checkbox"/>	<input type="checkbox"/>
Is the design infiltration rate within acceptable rates?	<input type="checkbox"/>	<input type="checkbox"/>
Is contaminated groundwater present?	<input type="checkbox"/>	<input type="checkbox"/>
Is the drainage area less than 5 acres? (If no, consider an infiltration basin or subdividing to create smaller drainage areas.)	<input type="checkbox"/>	<input type="checkbox"/>
Do utility conflicts make installation of the bioretention cell technically infeasible?	<input type="checkbox"/>	<input type="checkbox"/>
Do geotechnical conditions exist that compromise the stability of the bioretention cell or surrounding structures?	<input type="checkbox"/>	<input type="checkbox"/>
Does the bioretention cell provide storage for 100% of the water quality volume? (If no, it may still be appropriate to construct the bioretention cell if it is technically infeasible to capture 100% of the water quality volume.)	<input type="checkbox"/>	<input type="checkbox"/>
Does an overflow outlet structure or bypass mechanism exist?	<input type="checkbox"/>	<input type="checkbox"/>

Vegetation

Refer to [Vegetation Guidance by BMP Type](#).

Installation

Excavation

Bioretention cells, like other BMPs whose functionality is dependent on infiltration, will fail if proper care is not taken during excavation and construction. Excavators and heavy machinery should not be used within the excavated area if infiltration is expected to occur through the bioretention cell bottom. Additional excavation beyond the footprint may be required depending on site conditions to provide soil stability or to be able to tie-in to the surrounding grade.

Activities During Construction

Avoid using heavy machinery within the bioretention cell footprint during construction as doing so will further compact the soils and diminish their infiltrating capabilities. Light machinery and even walking within the bioretention cell's footprint will also compromise infiltration. Compaction of native soils or backfill below the bioretention cell subsoils is acceptable if doing so does not prevent infiltration from occurring.

Flows During Construction

Flows during construction should be diverted away from the bioretention cell to prevent construction site sediment from clogging soils. Scheduling installation of the bioretention cell shortly after excavation will minimize the impact of unnecessary storm water flows from entering the excavated area. The introduction of unwanted sediment can be prevented by placing fiber rolls or silt fences around the bioretention cell perimeter during construction.

Additional Guidance

- Require certificates of compliance to verify that construction items meet specification requirements.
- Follow landscaping guidance to ensure that vegetation establishes after installation.

Installation Costs

The following cost items are typically associated with bioretention cell construction.

- Excavation
- Landscaping and vegetation
- Top layer
- Engineered soil
- Coarse sand
- Crushed gravel
- Open graded stone
- Geotextile fabric
- Outlet structure or upstream bypass structure (for larger storm events)
- Observation wells
- Curb and gutter
- Impermeable liner (if needed)
- Underdrain system (if needed)
- Irrigation system (if needed)

Maintenance

Refer to *Maintenance* and *Maintenance Costs* in the *Preface to Fact Sheets* for general information related to maintenance of bioretention BMPs.

Maintenance Activities

Inspection	Inspection/Maintenance Frequency	Maintenance Activity	Effort
Inspect for adequate vegetative coverage, and impaired or failing vegetation.	Semiannual (Spring, Fall)	Reseed/replant barren spots. Notify the engineer if failing vegetation persists.	Low
Inspect for trash and debris within basin and at inlet and outlet structures.	Semiannual (Spring, Fall) or as needed	Remove and dispose of trash and debris.	Low
Inspect for large deposits of sediment on bottom indicating soil clogging.	Semiannual (Spring, Fall) or as needed	Remove and dispose of built up sediment when buildup causes reduction in size of basin or if buildup results in standing water. Notify the engineer in the case of standing water as it may indicate clogging within the basin's soil layers.	Low

Inspection	Inspection/Maintenance Frequency	Maintenance Activity	Effort
Inspect for standing water within bioretention cell or within observation well.	Semiannual (Spring, Fall)	Notify the engineer for further inspection.	Medium
Inspect for failure of additional features such as underdrains or irrigation systems.	Semiannual (Spring, Fall)	Repair as needed.	Medium

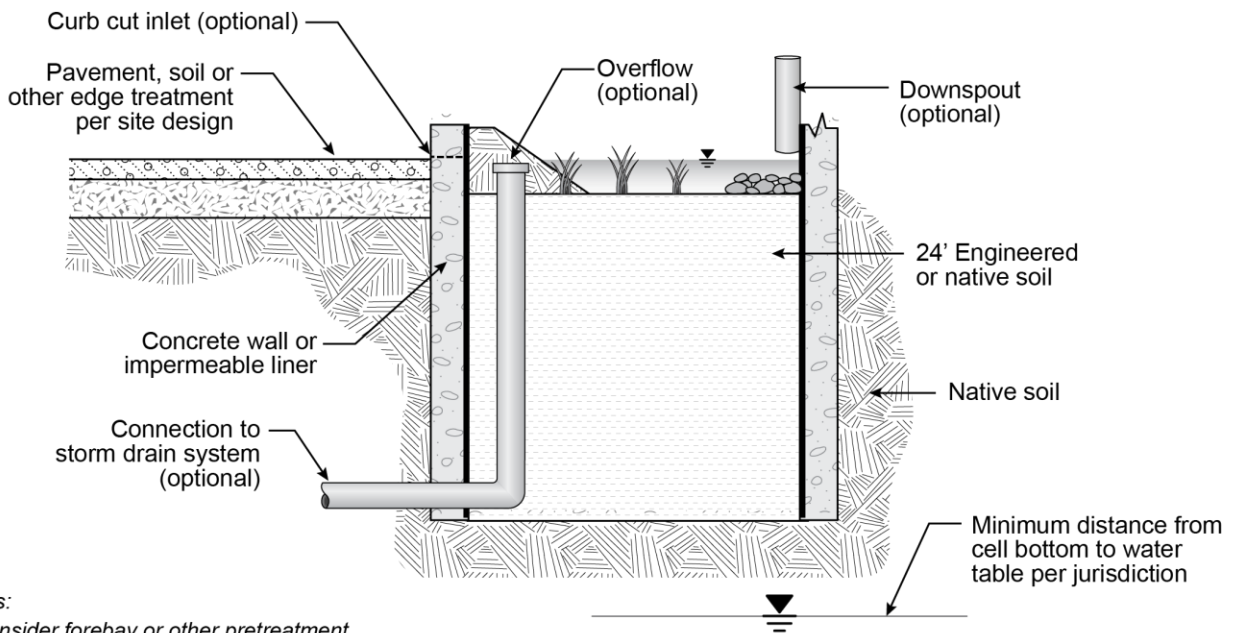

Notes:

- Consider forebay or other pretreatment
- Consider upstream bypass for large storm events

Bioretention Cell in Native or Engineered Soils

Not to scale

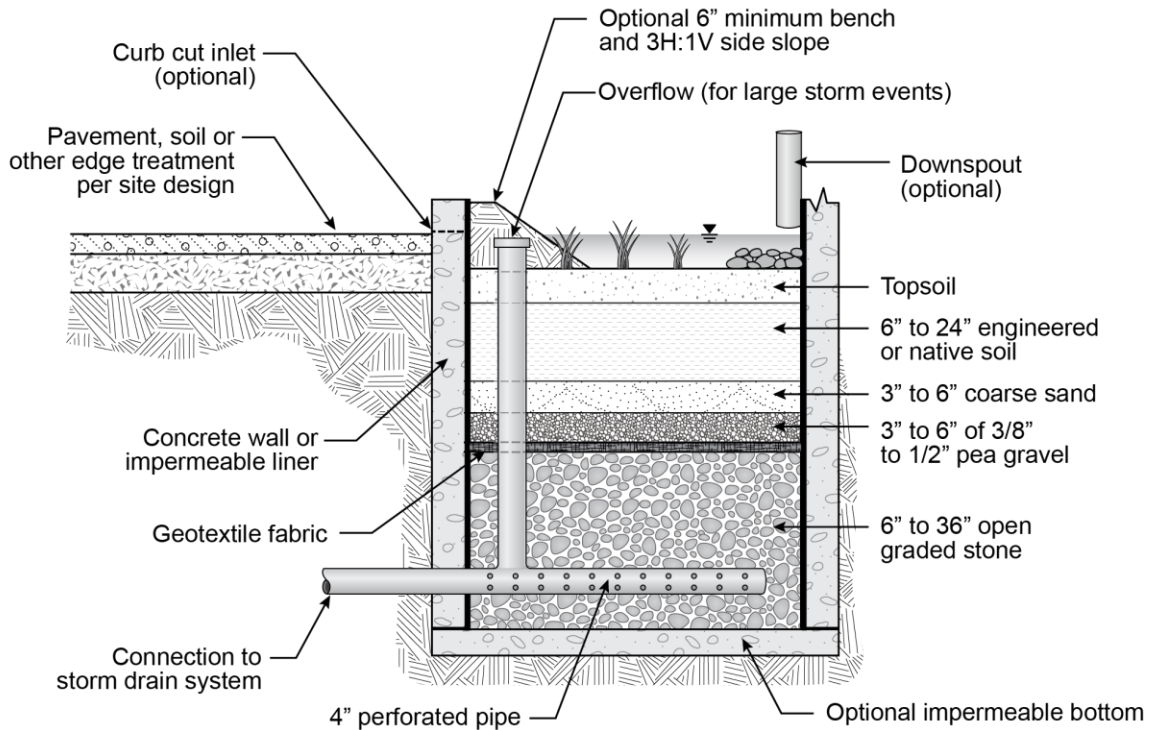

Notes:

- Overflow elevation must be below elevation of inlet (curb cut, downspout, or other per site design)
- Dimensions shown may vary based on site conditions
- Consider forebay or other pretreatment

Bioretention Cell with Underdrain System

Not to scale



Bioswale

BR-3



Pollutant Removal Effectiveness

Pollutant	Effectiveness ¹
Sediment	Medium
Nutrients	Medium
Metals	Medium
Bacteria	Medium
Oil/Grease	High

¹Removal effectiveness is increased for all pollutants as retention increases.

Bioswales are vegetated open channels designed to convey and treat storm water runoff. They are appropriate when it is desirable to convey flows away from structures or as an alternate conveyance method to pipes, concrete channels, or curbed gutters. Bioswales reduce peak flow rates, reduce flow velocities, filter storm water pollutants, and can also reduce runoff volume through infiltration.

The primary functions of bioswales are bioretention and treatment through biofiltration. Conveying runoff through bioswales allows the runoff to be filtered through two processes: bioretention through a native or engineered soil matrix and biofiltration through the above ground vegetation.

Although volume retention may be accomplished within the native soil or a subsoil matrix of engineered soil and gravel layers, retention is not its primary function. However, retention volumes may be determined by designing ponding areas within the swale or creating check dams. There is research to support the quantification of infiltration when runoff is simply conveyed through the swale (no ponding) but design parameters vary widely. Monitoring bioswales for volume reduction is the most reliable source for future estimates of expected reduction.

Primary Functions	
Bioretention	Yes
Volume Retention	Some
Biofiltration	Yes

Design Criteria

Refer to *Design Criteria* in the *Preface to Fact Sheets* for discussion of design criteria parameters.

Parameter	Min. Value	Max. Value	Notes
Length	Based on hydraulic residence time	No maximum	-
Longitudinal Slope	0.50%	5%	Underdrain recommended below minimum slope
Bottom Width	No minimum	No maximum	-
Side Slope	No minimum	3H:1V	Per jurisdiction requirements
Flow Velocity	No minimum	1.0 ft/s	Maximum permissible shear stress may also dictate maximum flow velocity
Flow Depth	No minimum	2/3 vegetation height	Flow depths greater than vegetation height will bypass the biofiltration processes
Freeboard	No minimum	No maximum	Per jurisdiction requirements
Vegetation Coverage	≥ 65%		Biofiltration is significantly reduced when vegetation coverage is less than 65%
Hydraulic Residence Time	5 min	No maximum	-

Calculation Methods

Bioswale design is governed by the water quality flow. The general design steps are:

1. Calculate the water quality flow.
2. Determine the geometry of the bioswale's cross-section.
3. Determine the flow depth.
4. Determine volume retention within bioswale, if any.
5. Check flow velocity and hydraulic residence time.

Sample Calculations

Refer to *Calculation Methods* in the *Preface to Fact Sheets* for discussion on the equations used.

During the planning phase of a city roadway project it has been decided to remove curbs and instead allow one acre of runoff to sheet flow into a 500 ft bioswale. There are 15 feet of available right-of-way between the edge of pavement and the project limits. A 4-foot sidewalk is also proposed to be within the right-of-way. The city has a requirement that there be no slopes greater than 6H:1V within five feet of the edge of pavement. The city's storm water requirements state that the 2-yr, 6-hr intensity must be used in determining the water quality flow rate. Per city standards, 6 inches of freeboard will be required above the water quality flow depth.

Given

Contributing drainage area: 1.0 ac

Imperviousness: 0.85

90th percentile storm depth: 0.60 in

2-yr, 6-hr storm intensity: 0.16 in/hr

Design Goals

Determine an acceptable swale bottom width and flow depth. Design a soil matrix and determine the volume of runoff that is expected to infiltrate into the bioswale.

Calculations

Volumetric runoff coefficient, R_V (See [Sample Calculations](#))

$$R_V = 1.14i - 0.371 \text{ (Granato method when } i \geq 0.55)$$

$$R_V = 1.14(0.85) - 0.371$$

$$R_V = 0.60$$

Water quality flow, WQF

$$WQF = R_V i A$$

$$WQF = (0.60)(0.16 \text{ in/hr})(1.0 \text{ ac})$$

$$WQF = 0.10 \text{ cfs}$$

Flow depth, y_d (See [Manning's Equation](#))

The project team has decided that a 2-foot bottom width will be used for the bioswale. Per city standards, 6 inches of freeboard will be required above the water quality flow depth. Other design information for the bioswale includes:

Longitudinal slope: 2.0%

Side slopes: 3H:1V

Determine the flow depth during the design storm event by setting Manning's equation equal to the WQF and solving the equation for the flow depth, y_d . This calculation is made easier using a goal seek function within a spreadsheet.

$$y_d = 1.8 \text{ in}$$

Velocity, v (See [Continuity Equation](#))

The city requires that flows remain below 1 ft/s to prevent scouring of the bioswale bottom. With the flow depth known, the continuity equation can be used to determine the flow velocity. The cross-sectional area is calculated to be 0.37 sf.

$$v = Q/A$$

$$v = (0.10 \text{ cfs}) / (0.37 \text{ sf})$$

$$v = 0.26 \text{ ft/s}$$

Minimum swale length, L_{\min}

The city also requires a 5-minute minimum hydraulic residence time to achieve the maximum desired biofiltration. Using the velocity, a minimum swale length can be determined.

$$L_{\min} = (0.26 \text{ ft/s})(300 \text{ s})$$

$$L_{\min} = 79 \text{ ft}$$

Any portion of the runoff that enters the swale within 79 ft of the downstream end of the swale will not receive the optimal treatment.

With 6 inches of freeboard and a side slope of 3H:1V, the top width of the bioswale is 6.00 ft. With 15 feet of available right-of-way, 6 of which are available for the swale, at the planning level there is adequate space for the bioswale. If needed, the swale's top width could be narrowed by decreasing the bottom width, which would also result in a deeper flow depth.

Water quality volume, WQV (See *Developing the 90th Percentile Volume*)

$$WQV = (0.60)(0.60 \text{ in})(1.0 \text{ ac})(43,560 \text{ sf/ac}) / (12 \text{ in/ft})$$

$$WQV = 1,302 \text{ cf}$$

Volume Reduction

The swale will also include check dams that are 6 inches high to increase the volume retention. With a longitudinal slope of 2%, a 6-inch check dam will create a triangular pool that is 25 ft long before overtopping the check dam. The volume retained behind the check dam is calculated with the bottom width, the check dam height, and the length of the check dam pool.

$$V_{\text{check dam}} = (2 \text{ ft})(25 \text{ ft})(0.5 \text{ ft}) / 2$$

$$V_{\text{check dam}} = 12.50 \text{ cf}$$

If the check dams are spaced every 50 feet, 10 check dams are possible, and the total volume retained by the check dams will be 125 cf.

Additional volume retention can be achieved in any ponding areas that are designed into the swale.

Although methodologies have been developed to determine volume retention within a bioswale, the current body of research varies widely and jurisdictions are encouraged to exercise engineering judgment (See *Volume Reduction*).

A conservative design for the soil matrix below the swale will allow for the maximum possible percentage of the water quality volume to be captured. For flood control purposes, zero infiltration may be assumed to prevent downstream piping from being undersized if the bioswale's volume reduction is overestimated. Accounting for the ten check dams, the soil matrix below will provide storage for the remaining portion of the water quality volume (1,182 cf). Whether the full remaining volume is captured can be determined by monitoring the bioswale for volume retention.

Layer	Thickness, in	Porosity	Storage Volume, cf
Engineered Soil	12	0.25	250
Coarse Sand	3	0.35	87.5
Pea Gravel	3	0.25	62.5
Aggregate Storage	20	0.4	667
Total	52 (soil layers)	0.35 (soil layers weighted)	1067 (includes ponding)

Bioswale Effectiveness

Bioswales are effective when they can accomplish their design goals of conveying flows to a downstream receiving structure, BMP, or other receiving area. Flows through the swale should be relatively steady and uniform during a rain event unless retention areas and check dams are part of the swale design. Established vegetation with adequate coverage is an indication of a healthy bioswale along with minimal sediment and lack of invasive vegetation.

Designer Checklist

If the answer to these questions corresponds to a response box that is red, the BMP should either not be used or additional measures need to be taken to address the issue.

	<u>Yes</u>	<u>No</u>
If longitudinal slope is less than minimum, can an underdrain be installed?	<input type="checkbox"/>	<input type="checkbox"/>
If an underdrain is needed, is sufficient hydraulic head available for proper drainage?	<input type="checkbox"/>	<input type="checkbox"/>
Do flows result in a shear stress greater than the maximum permissible for selected vegetation?	<input type="checkbox"/>	<input type="checkbox"/>
Do utility conflicts make installation of the bioswale technically infeasible?	<input type="checkbox"/>	<input type="checkbox"/>
Will the bioswale provide conveyance for larger storm events? (If yes, the geometry of the bioswale will need to accommodate the larger events.)	<input type="checkbox"/>	<input type="checkbox"/>
Is the bioswale providing pretreatment for a downstream BMP?	<input type="checkbox"/>	<input type="checkbox"/>
Is the bioswale connecting directly to the storm drain network? (If yes, the outlet structure elevation will need to be determined.)	<input type="checkbox"/>	<input type="checkbox"/>

Vegetation

Refer to [Vegetation Guidance by BMP Type](#).

Installation

Excavation

Bioswale construction is a relatively straightforward process of excavating the swale's subsurface trench prior to backfilling with any underdrain system, open graded stone, engineered soil, and geotextile fabric. Additional excavation beyond the swale's footprint may be required depending on site conditions to provide soil stability or to be able to tie-in to the surrounding grade.

Activities During Construction

Crews should avoid stepping within the trench except when necessary as doing so will compact the native soil that is expected to infiltrate runoff.

Flows During Construction

Flows during construction should be diverted away from the bioswale to prevent construction site sediment from clogging soils and to prevent erosion of the swale bed. Scheduling installation of the bioswale shortly after excavation will minimize the impact of unnecessary storm water flows from entering the excavated area. The introduction of unwanted sediment can be prevented by placing fiber rolls or silt fences around the bioswale perimeter during construction. Creating the upstream inlet or connection should be the last construction activity before flows are permitted to be conveyed as designed through the bioswale.

Additional Guidance

- Require certificates of compliance to verify that construction items meet specification requirements.
- Follow landscaping guidance to ensure that vegetation establishes after installation.

Installation Costs

The following cost items are typically associated with bioswale construction.

- Excavation
- Grading
- Fine grading
- Granular borrow fill
- Landscaping and vegetation
- Top layer
- Engineered soil
- Open graded stone
- Geotextile fabric
- Impermeable liner
- Outlet structure or upstream bypass structure (for larger storm events)
- Observation wells
- Underdrain system (if needed)
- Outlet protection such as riprap or other (if needed)

Maintenance

Refer to *Maintenance* and *Maintenance Costs* in the *Preface to Fact Sheets* for general information related to maintenance of bioretention BMPs.

Maintenance Activities

Inspection	Inspection/Maintenance Frequency	Maintenance Activity	Effort
Inspect for adequate vegetative coverage, and impaired or failing vegetation.	Semiannual (Spring, Fall)	Reseed/replant barren areas. Notify engineer if issue persists.	Low
Inspect side slopes for erosion, rilling, and sloughing.	Semiannual (Spring, Fall)	Regrade side slope if slope stability is not affected by sloughing. Notify engineer if stability is affecting basin functionality.	Low
Inspect for standing water within bioswale or within observation well.	Semiannual (Spring, Fall)	Notify engineer for further inspection.	Medium
Inspect for trash and debris at inlet and outlet structures.	Prior to mowing, at least semiannually	Remove trash and debris.	Low
Inspect vegetation height.	As needed	Mow swale as needed.	Low

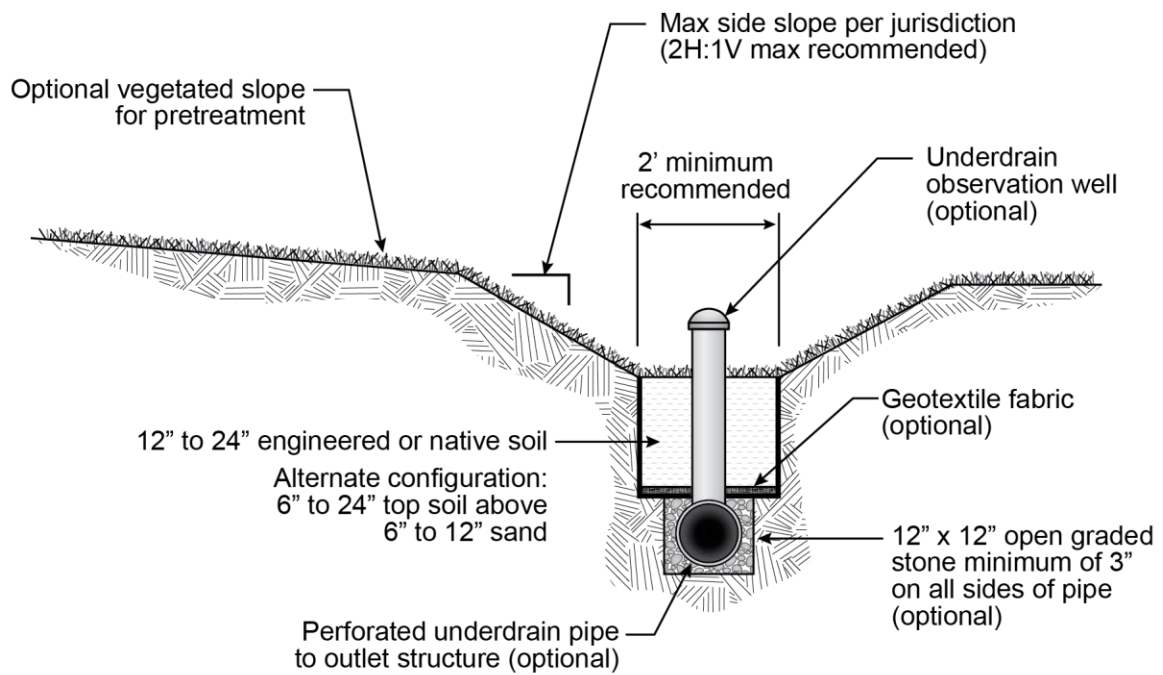

Notes:

- *Engineered soil may improve filtration*
- *Underdrain recommended for longitudinal slopes < 1%*
- *Optional items shown for use of underdrain*
- *Dimensions shown may vary based on site conditions*

Bioswales

Not to scale



Vegetated Strip

BR-4



Pollutant Removal Effectiveness

Pollutant	Effectiveness ¹
Sediment	High
Nutrients	Medium
Metals	Medium
Bacteria	High
Oil/Grease	High

¹Removal effectiveness is increased for all pollutants as retention increases.

Vegetated strips are designed to receive and treat sheet flow from adjacent surfaces. This is accomplished by slowing runoff velocity to allow for pollutants and sediments to settle and by filtering out pollutants in the vegetation before entering the storm sewer system. Vegetated strips are best utilized for storm water treatment from roads, parking lots, and other impervious surfaces.

The primary functions of vegetated strips are bioretention and biofiltration. Bioretention within a vegetated strip occurs as runoff enters the soil and pollutants are removed through physical, chemical, and biological processes. Similar biofiltration processes occur to provide treatment when runoff passes through the strip’s vegetation. Biofiltration is significantly reduced when vegetation coverage is less than 65%. In arid locations a gravel strip may be used as a substitute for the vegetated strip. The lack of vegetation will cause biofiltration and bioretention to be greatly reduced; however, the runoff velocity will still be decreased and allow for pollutants and sediments to settle out. Volume retention through infiltration will also occur as runoff enters the gravel’s void spaces.

Primary Functions	
Bioretention	Yes
Volume Retention	Some
Biofiltration	Yes

Design Criteria

Refer to *Design Criteria* in the *Preface to Fact Sheets* for discussion of design criteria parameters.

Parameter	Min. Value	Max. Value	Notes
Length (direction of flow travel)	15 ft	No maximum	-
Longitudinal Slope	No minimum	4H:1V	Per jurisdiction requirements
Flow Velocity	No minimum	1.0 ft/s	Maximum permissible shear stress may also dictate maximum flow velocity
Flow Depth	No minimum	2/3 vegetation height	Flow depths greater than vegetation height will bypass the biofiltration processes
Freeboard	No minimum	No maximum	Per jurisdiction requirements
Vegetation Coverage	≥ 65%		Biofiltration is significantly reduced when vegetation coverage is less than 65%

Calculation Methods

Vegetated strip design is governed by the water quality flow. The general design steps are:

1. Calculate the water quality flow.
2. Determine the flow depth.
3. Check flow velocity.

Sample Calculations

Refer to *Calculation Methods* in the *Preface to Fact Sheets* for discussion on the equations used.

A roadway project is proposing to widen a road that is near a canal. Due to high groundwater and poor soils, retention on-site is not feasible. Treatment is still an option, however, and the design team has decided to establish vegetation within the twenty feet between the edge of pavement and the canal. The city's storm water requirements state that the 2-yr, 2-hr intensity must be used in determining the water quality flow rate.

Given

Contributing drainage area: 0.25 ac

Imperviousness: 1.00

2-yr, 2-hr storm intensity: 0.318 in/hr

Design Goals

Determine that the flow depth will be less than 1 inch.

Calculations

Volumetric runoff coefficient, R_V (See *Sample Calculations*)

$$R_{V-A} = 0.84i^{1.302} \text{ (} R_V \text{ based on hydrologic soil group)}$$

$$R_V = 0.84(1.0)^{1.302}$$

$$R_v = 0.84$$

Water Quality Flow, WQF

$$WQF = R_v i A$$

$$WQF = (0.84)(0.318 \text{ in/hr})(0.25 \text{ ac})$$

$$WQF = 0.067 \text{ cfs}$$

There is available right-of-way for a 300-foot long strip that is 20 feet wide. The embankment side slope is 10H:1V which corresponds to a 10% longitudinal slope for the vegetated strip.

Flow depth, y_d (See [Manning's Equation](#))

Calculation of the flow depth is typically done using Manning's equation setting the equation equal to the water quality flow and solving for the flow depth.

$$y_d = [(nQ)/1.49LS^{0.5}]^{0.6}$$

$$y_d = [(0.2)(0.071 \text{ cfs}) / (1.49)(300 \text{ ft})(0.02)^{0.5}]^{0.6}$$

$$y_d = 0.04 \text{ in}$$

Velocity, v (See [Continuity Equation](#))

The city requires that flows remain below 1 ft/s to prevent scouring of the strip bottom. With the flow depth known, the cross-sectional area is calculated to be 1.10 sf.

$$v = Q/A$$

$$v = 0.067 \text{ cfs} / 1.10 \text{ sf}$$

$$v = 0.06 \text{ ft/s}$$

Volume Reduction

Although methodologies have been developed to determine volume retention within a bioswale, the current body of research varies widely and jurisdictions are encouraged to exercise engineering judgment (See [Volume Reduction](#)).

Vegetated Strip Effectiveness

Vegetated strips are effective when they can accomplish their design goals of conveying sheet flow to the receiving area. Flows through the vegetated strip should be relatively steady and uniform during a rain event and should not create rilling or other visible signs of erosion. Established vegetation with adequate coverage is an indication of a healthy vegetated strip along with minimal sediment and lack of invasive vegetation.

Designer Checklist

If the answer to these questions corresponds to a response box that is red, the BMP should either not be used or additional measures need to be taken to address the issue.

Yes **No**

Is the vegetated strip length greater than or equal to the minimum required length?

Do flows result in a shear stress greater than the maximum permissible for selected vegetation?	<input type="checkbox"/>	<input type="checkbox"/>
Is the vegetated strip providing pretreatment for a downstream BMP?	<input type="checkbox"/>	<input type="checkbox"/>
Is the slope in the direction of flow less than or equal to the jurisdiction's standards?	<input type="checkbox"/>	<input type="checkbox"/>

Vegetation

Refer to [Vegetation Guidance by BMP Type](#).

Installation

Vegetated strips can be installed as part of normal construction activities. An appropriate grass such as turf sod should be installed per specifications. If additional vegetation such as shrubs or bushes will be used within the strip, follow landscaping guidance to ensure that vegetation establishes after installation. To maximize infiltration performance, minimize use of heavy machinery.

Additional Guidance

- Require certificates of compliance to verify that construction items meet specification requirements.

Installation Costs

The following cost items are typically associated with bioswale construction.

- Grading
- Landscaping and vegetation
- Topsoil
- Engineered soil
- Shoulder dressing upstream of vegetated strip

Maintenance

Refer to [Maintenance](#) and [Maintenance Costs](#) in the [Preface to Fact Sheets](#) for general information related to maintenance of bioretention BMPs.

Maintenance Activities

Inspection	Inspection/Maintenance Frequency	Maintenance Activity	Effort
Inspect upstream end of vegetated strip for sediment buildup that may be impeding sheet flow.	Semiannual (Spring, Fall) or as needed	Remove and dispose of sediment buildup.	Low
Inspect grass length.	As needed	Mow strip as needed.	Low
Inspect for erosion, rilling, and sloughing.	Semiannual (Spring, Fall)	Regrade side slope if slope stability is not affected by sloughing. Notify engineer if stability is affecting basin functionality.	Low
Inspect for adequate vegetative coverage, and impaired or failing vegetation.	Semiannual (Spring, Fall) or as needed	Reseed/replant barren areas. Notify engineer if issue persists.	Low

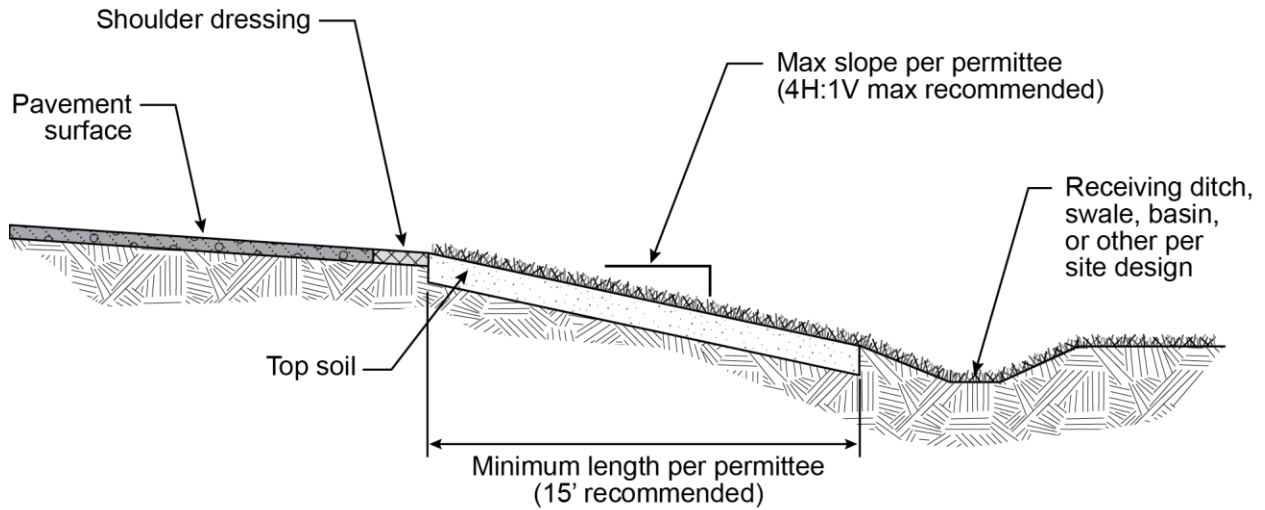

Notes:

- Dimensions shown may vary based on site conditions

Vegetated Strips

Not to scale



Tree Box Filter

BR-5



Pollutant Removal Effectiveness

Pollutant	Effectiveness
Sediment	High
Nutrients	Medium
Metals	Medium
Bacteria	High
Oil/Grease	High

Source: Montgomery County, Maryland Department of Environmental Protection

Tree box filters are bioretention systems that are appropriate in urban drainage areas where space is limited. An underground concrete vault contains the soil matrix that provides bioretention and has a grated top where vegetation grows. Tree box filters are typically designed as flow-through devices, meaning that they do not retain storm water but rather allow flows to pass through them. However, a bottomless concrete vault will function as a bioretention system that provides infiltration into the native soils. Manufacturers have developed proprietary designs for tree box filters, but they may also be designed.

The primary functions of tree box filters are bioretention and treatment. Runoff from the contributing drainage area enters the tree box through an inlet where bioretention occurs. Storm water is treated by the physical, chemical, and biological processes that occur within the mulch, soil matrix, and plant roots.

Primary Functions	
Bioretention	Yes
Volume Retention	Varies ¹
Biofiltration	Yes

¹Volume retention may be achieved with a bottomless vault.

Design Criteria

Refer to *Design Criteria* in the *Preface to Fact Sheets* for discussion of design criteria parameters. Tree box filters may be proprietary devices; follow manufacturer specifications to determine design criteria on a case-by-case basis.

Parameter	Min. Value	Max. Value	Notes
Depth to Historical High Groundwater	2 ft	No maximum	May be less than 2 feet if tree box filter has impermeable bottom.
Ponding Depth	No minimum	12 in	-
Drawdown Time	12 hours	72 hours	24 to 48 hours preferred. Drawdown time may also depend on local mosquito abatement regulations.
Design Infiltration Rate	0.25 in/hr	6 in/hr	Field testing required for final design. Infiltration rate should be low enough to allow biofiltration processes to occur. During design, infiltration rate, drawdown time, and the soil matrix depth will be directly related.

Calculation Methods

Tree box filters are typically sized based on their water quality flow but may be sized for their water quality volume when being designed for retention. Both design approaches are dependent on the contributing drainage area and imperviousness. A larger contributing drainage area will require a larger tree box filter.

Tree Box Filter Effectiveness

Tree box filters are effective when they maintain their bioretention and biofiltration capabilities. Proper inspection and maintenance of tree box filters will ensure that the chemical and biological processes that treat runoff perform optimally. Qualified inspection crews are necessary to determine if soils and vegetation are healthy.

The tree box must be able to function hydraulically. Flows must be able to pass through the filter without backing up or maintenance will be required.

Designer Checklist

If the answer to these questions corresponds to a response box that is red, the BMP should either not be used or additional measures need to be taken to address the issue.

	<u>Yes</u>	<u>No</u>
Is there adequate space for a tree box filter?	<input type="checkbox"/>	<input type="checkbox"/>
Is there sufficient hydraulic head for tree box filter to connect to storm drain network?	<input type="checkbox"/>	<input type="checkbox"/>
If retention is desired, will the design infiltration rate permit a reasonable drawdown time?	<input type="checkbox"/>	<input type="checkbox"/>
If retention is desired, is depth to the historical high groundwater from the filter bottom greater than the jurisdiction's minimum separation requirement?	<input type="checkbox"/>	<input type="checkbox"/>

Vegetation

Refer to *Vegetation Guidance by BMP Type*.

Maintenance

Refer to *Maintenance* and *Maintenance Costs* in the *Preface to Fact Sheets* for general information related to maintenance of bioretention BMPs.

Maintenance Activities

Proper maintenance of tree box filters will be per the manufacturer's specifications, but it typically includes the following:

Inspection	Inspection/Maintenance Frequency	Maintenance Activity	Effort
Inspect for trash and debris within tree box filter and at inlet and outlet structures.	Semiannual (Spring, Fall) or as needed	Remove trash, debris and sediment.	Low
Inspect performance.	Semiannual (Spring, Fall)	Replenish media filter layer with new mulch.	Medium
Inspect for invasive species.	Semiannual (Spring, Fall)	Prune and weed filter box.	Medium

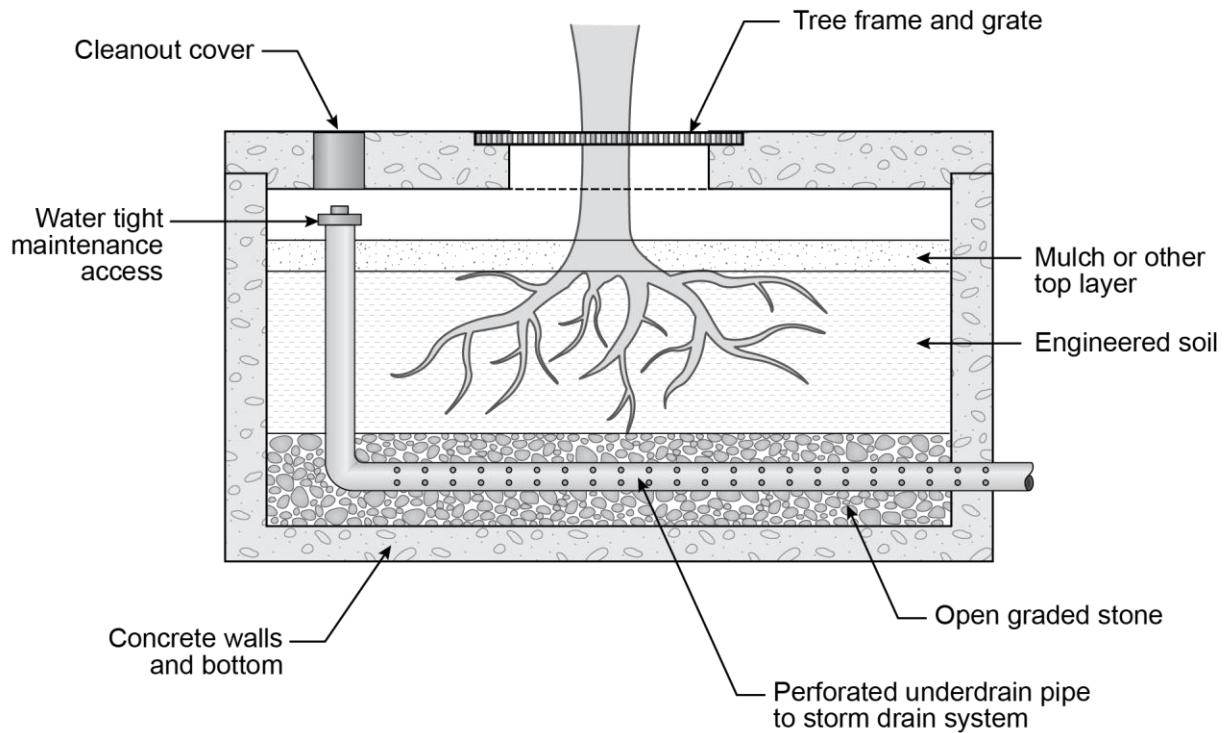

Notes:

- Dimensions shown may vary based on site conditions

Tree Box Filters

Not to scale



Green Roof

BR-6



Pollutant Removal Effectiveness

Pollutant	Effectiveness ¹
Sediment	High
Nutrients	Medium ²
Metals	High
Bacteria	High
Oil/Grease	-

¹Removal effectiveness is increased for thicker soil layers.

²Use of organic matter to establish vegetation may increase nutrient leaching.

A green roof is a vegetated system that is designed to retain and treat rooftop runoff. The primary functions of green roofs are bioretention, volume retention, and filtration. Green roofs capture storm water within the pore space of the soil and vegetation and the moisture is then released through evapotranspiration.

Green roofs can be classified as either extensive or intensive systems. Extensive systems are those in which the soil media is up to 6 inches in depth and support smaller grasses and other vegetative species that do not have deep root systems. Intensive systems are those that support root systems greater than 6 inches such as those from trees and bushes.

The design of green roofs should be done with the coordination of qualified landscaping, structural, and maintenance teams. Vegetation selection and the proper maintenance of vegetation are critical items in the overall performance and functionality of the green roof. The integrity of the roof structure must also be accounted for as large volumes of plants, soils, water, and the weight of the green roof structure will create additional loads on the building.

Primary Functions	
Bioretention	Yes
Volume Retention	Yes
Biofiltration	Yes

Design Criteria

Refer to *Design Criteria* in the *Preface to Fact Sheets* for discussion of design criteria parameters.

Parameter	Extensive	Intensive	Notes
Drawdown Time	12 hours	12 hours	-
Growth Media Depth	< 6 in	6+ in	-
Vegetation	Low growing, low water-use vegetation such as Sedum, herbs, grasses, and perennials	More complex gardens including the species listed for extensive green roofs, but also incorporating trees and shrubs.	-
Load	12-54 lb/sf	72+ lb/sf	-
Roof Slope	5:1 maximum	5:1 maximum	-
Access	Required for maintenance	Required for maintenance	-
Irrigation	Simple irrigation. Only needed during droughts and plant establishment if well designed.	Complex irrigation	-
Drainage	Simple drainage system	Complex drainage system	-

Calculation Methods

Green roof design is governed by the water quality volume; however, special consideration must also be given to vegetation selection and proper installation with the assistance of a landscape architect or other qualified person. Special consideration must also be given to the structural design of the roof, with the assistance of a structural engineer. Neither of those considerations are considered in this discussion of calculation methods. For the purposes of determining if the green roof retains the water quality volume, the general design steps are:

1. Calculate the water quality volume.
2. Determine the porosity of the engineered soil used within the green roof and the retention volume within the soil.
3. Determine the required footprint to retain the water quality volume.

Sample Calculations

Refer to *Calculation Methods* in the *Preface to Fact Sheets* for discussion on the equations used.

An extensive green roof system will be designed for a new building with a roof that is 0.37 acres. The entire roof will drain to the green roof. It was decided that an extensive green roof system with a 6-inch soil matrix will be used. Determine the footprint that will be needed to capture the water quality volume.

Given

Roof area: 0.37 ac

85th percentile storm depth: 0.60 in

Porosity of engineered soil: 0.25

Determine

Determine the footprint of the green roof.

Calculations

The footprint can be determined through iterative calculations. After iterative calculations, it was found that a footprint of 3,405 square feet will capture the water quality volume.

Pervious area (green roof footprint): 3,405 sf (0.078 ac)

Imperviousness of rooftop: 0.79

Volumetric runoff coefficient, R_V (See *Sample Calculations*)

$R_V = 0.91i - 0.0204$ (Reese method)

$R_V = 0.91(0.79) - 0.0204$

$R_V = 0.70$

Water quality volume, WQV (See *Developing the 90th Percentile Volume*)

$WQV = (0.70)(0.60 \text{ in})(16,117 \text{ sf}) / (12 \text{ in/ft})$

$WQV = 562 \text{ cf}$

Determine the equivalent storage depth of the engineered soil.

$d_{\text{equivalent}} = (0.6 \text{ in})(0.25)$

$d_{\text{equivalent}} = 1.5 \text{ in}$

Determine the required footprint of the green roof to capture the water quality volume.

$\text{Footprint} = WQV / d_{\text{equivalent}}$

$\text{Footprint} = 562 \text{ cf} / (1.5 \text{ in})(12 \text{ in/ft})$

$\text{Footprint} = 4,496 \text{ sf}$

Green Roof Effectiveness

Green roofs provide an aesthetically pleasing method for retaining and treating storm water runoff. Healthy plants and soils are indications that the green roof is performing as expected. Excessive drainage through the soil layer may be an indication that the soils and vegetation are not retaining runoff; consequently, the evaporation and transpiration processes are not occurring. Qualified horticulturists and/or green roof contractors should be involved in determining the health and effectiveness of the green roof.

Designer Checklist

If the answer to these questions corresponds to a response box that is red, the BMP should either not be used or additional measures need to be taken to address the issue.

	<u>Yes</u>	<u>No</u>
Has a landscape architect been involved in the vegetation selection?	<input type="checkbox"/>	<input type="checkbox"/>
Has a structural engineer been involved in the green roof design?	<input type="checkbox"/>	<input type="checkbox"/>
Are maintenance crews trained and aware of maintenance responsibilities?	<input type="checkbox"/>	<input type="checkbox"/>

Does the green roof provide storage for 100% of the water quality volume? (If no, it may still be appropriate to construct the green roof if it is technically infeasible to capture 100% of the water quality volume.)	<input type="checkbox"/>	<input type="checkbox"/>
Will the green roof partially cover or fully cover the roof?	-	-
Will the green roof be extensive or intensive?	-	-

Vegetation

Refer to [Vegetation Guidance by BMP Type](#).

Installation

Green roof installation should be done with proper oversight from qualified environmental or green roof specialists. Any requirements related to working on rooftops should be followed. During construction, vegetation and the growth media should be protected from erosion until vegetation has been established.

Additional Guidance

- Require certificates of compliance to verify that construction items meet specification requirements.

Installation Costs

The following cost items are typically associated with rain garden construction.

- Vegetation and landscaping expertise
- Horticulturist expertise
- Structural expertise

Maintenance

Refer to [Maintenance](#) and [Maintenance Costs](#) in the [Preface to Fact Sheets](#) for general information related to maintenance of green roofs.

Maintenance Activities

Inspection	Inspection/Maintenance Frequency	Maintenance Activity	Effort
Inspect weed growth.	2-4 weeks during growing season	Remove weeds before they flower.	High
Inspect fertilization.	Annually	Apply fertilizer in accordance with manufacturer recommendations. Avoid hottest/driest parts of the year.	Medium
Inspect water retention.	Semiannual (Spring, Fall) or as needed	If natural precipitation is not adequate for vegetation, water plants.	High

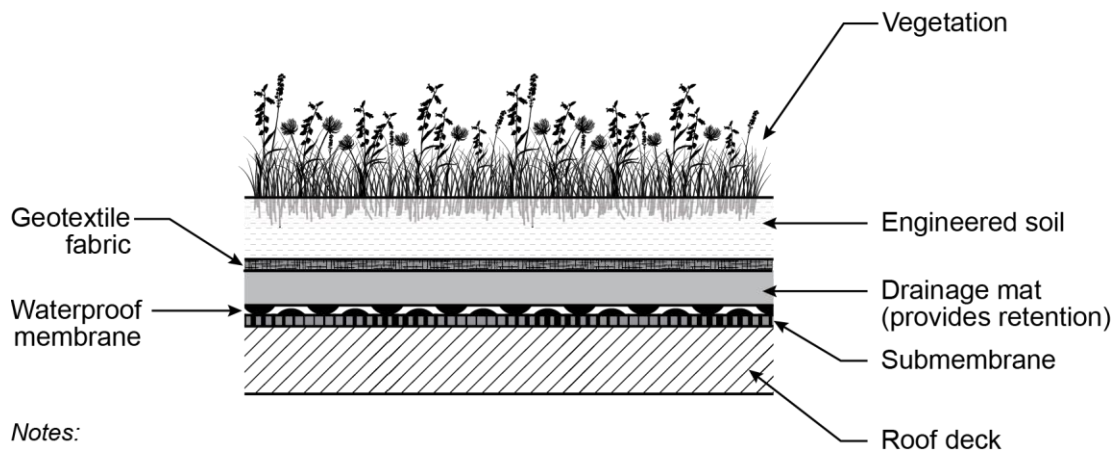

Notes:

- *Dimensions shown may vary based on site conditions*

Green Roof

Not to scale



Pervious Surfaces

PS-1



Pollutant Removal Effectiveness

Pollutant	Effectiveness ¹
Sediment	High
Nutrients	High
Metals	High
Bacteria	High
Oil/Grease	High

¹Pollutant removal may occur in the pervious surface or the subsurface.

Pervious surfaces such as permeable pavement, concrete pavers, pervious concrete, modular open pavers, and other types of pervious surfaces provide structural support for light vehicle or pedestrian traffic while also providing open space for storm water infiltration.

The primary function of pervious surfaces is volume retention, but some filtration is possible depending on the type of paver and subsurface selected. A modular open paver that, when installed, provides a certain percentage of pervious area in the form of grass, will allow for filtration processes to occur. Another source of filtration is the choker layer directly beneath the pervious surface.

The subsections beneath the pervious surface are typically a choker layer composed of small gravel and a storage layer of larger rock beneath. Underdrains may be required if existing soils do not adequately infiltrate.

Primary Functions	
Bioretention	Yes ¹
Volume Retention	Yes
Biofiltration	Some
¹ Bioretention occurs in the subsurface and not within the pervious surface.	

Design Criteria

Refer to *Design Criteria* in the *Preface to Fact Sheets* for discussion of design criteria parameters.

Parameter	Min. Value	Max. Value	Notes
Drain Time	12 hours	72 hours	-
Design Infiltration Rate	0.25 in/hr	6 in/hr	Field testing required for final design.
Depth to Historical High Groundwater	2 ft	No maximum	-

Calculation Methods

Pervious surface design is governed by the water quality volume. The general design steps are:

1. Calculate the water quality volume.
2. Determine the required thickness of the subsection layers given their porosity and the footprint of the pervious surface area.

Sample Calculations

Refer to *Calculation Methods* in the *Preface to Fact Sheets* for discussion on the equations used.

A development in the planning phase will have a 0.90-acre parking lot. It is proposed that the parking lot be graded so that runoff is conveyed towards stalls that will be constructed with permeable asphalt.

Given

Contributing drainage area: 0.90 ac

Imperviousness: 0.95

85th percentile storm event: 0.53 in

Design infiltration rate: 0.5 in/hr

Design Goals

Determine an acceptable area size and depth of the permeable asphalt section.

Calculations

Volumetric runoff coefficient, R_V (See *Sample Calculations*)

$$R_V = 1.14i - 0.371 \text{ (Granato method when } i \geq 0.55)$$

$$R_V = 1.14(0.95) - 0.371$$

$$R_V = 0.71$$

Water quality volume, WQV (See *Developing the 90th Percentile Volume*)

$$WQV = (0.71)(0.53 \text{ in})(0.90 \text{ ac})(43,560 \text{ sf/ac}) / (12 \text{ in/ft})$$

$$WQV = 1,230 \text{ cf}$$

A permeable asphalt area that is 15 ft x 140 ft (2,100 sf) with the following properties will retain the water quality volume and will have an acceptable drawdown time. See *Storage volume within a media with a known porosity* for guidance on determining storage within soils.

Layer	Thickness, in	Porosity	Storage Volume, cf
Permeable Asphalt	4	0.2	140
Choker Layer	4	0.4	280
Aggregate Storage	12	0.4	840
Total	20	0.37 (weighted)	1260

Drawdown time, t

$t = \text{Equivalent storage depth} / \text{Design infiltration rate}$

Weighted porosity, $n_w = 0.37$

Equivalent storage depth = (20 in)(0.37)

Equivalent storage depth = 7.2 in

$t = (7.2 \text{ in}) / (0.5 \text{ in/hr})$

$t = 14.40 \text{ hrs}$

Pervious Surface Effectiveness

Pervious surfaces are effective when runoff from the design storm depth can enter the porous spaces of the pervious surface and successfully infiltrate into the native soil or drain through an underdrain system. Visual inspection of the pervious surface can reveal reasons for failure: for example, sediment-laden sheet flows that are conveyed to the pervious surface, or a down drain might be introducing organic material. Both scenarios are likely to contribute to clogging within the porous spaces of the pervious surface or within the sublayers.

Designer Checklist

If the answer to these questions corresponds to a response box that is red, the BMP should either not be used or additional measures need to be taken to address the issue.

	<u>Yes</u>	<u>No</u>
Will an underdrain system be required?	<input type="checkbox"/>	<input type="checkbox"/>
If an underdrain is needed, is there sufficient head for the underdrain system to drain?	<input type="checkbox"/>	<input style="color: red;" type="checkbox"/>
Has the proposed pervious surface performed successfully in similar climate conditions?	<input type="checkbox"/>	<input style="color: red;" type="checkbox"/>

Installation

Excavation

Pervious surfaces will fail if proper care is not taken during excavation and construction. Excavators and heavy machinery should not be used if infiltration is expected to occur through the underlying soils beneath the pervious surface's subsection.

Activities During Construction

Avoid using heavy machinery on the revealed soil during construction. Crews should avoid unnecessarily walking on the underlying soils when possible. Compaction of native soils or backfill below the pervious surface subsoils is acceptable if doing so does not prevent infiltration from occurring.

Flows During Construction

Flows during construction should be diverted away from the exposed underlying soil to prevent erosion. Scheduling installation of the pervious surface within a short time span after excavation will minimize the impact of unnecessary storm water flows from entering the excavated area. The introduction of unwanted sediment and storm water flows can be prevented by placing fiber rolls or silt fences around the excavated perimeter during construction.

Additional Guidance

- Require certificates of compliance to verify that construction items meet specification requirements.

Installation Costs

The following cost items are typically associated with construction of pervious surfaces.

- Excavation
- Grading
- Fine grading
- Pervious surface
- Top layer
- Engineered soil
- Choker layer
- Open graded stone
- Geotextile fabric
- Impermeable liner
- Observation wells (if needed)
- Underdrain system (if needed)

Maintenance

Refer to *Maintenance* and *Maintenance Costs* in the *Preface to Fact Sheets* for general information related to maintenance of pervious surfaces.

Maintenance Activities

Inspection	Inspection/Maintenance Frequency	Maintenance Activity	Effort
Inspect for sediment accumulation.	Semiannual (Spring, Fall)	Use vacuum sweeper followed by pressure washing.	Medium
Inspect for weed growth.	Semiannual (Spring, Fall)	Remove weeds.	LOW
Inspect for standing water on surface or within observation well (if used).	Semiannual (Spring, Fall)	Notify engineer for further inspection.	LOW
Inspect surface for deterioration.	Annual	Notify engineer for further inspection.	LOW
Inspect exfiltration and drainage performance.	As needed, at least annually	Notify engineer for further inspection.	Medium

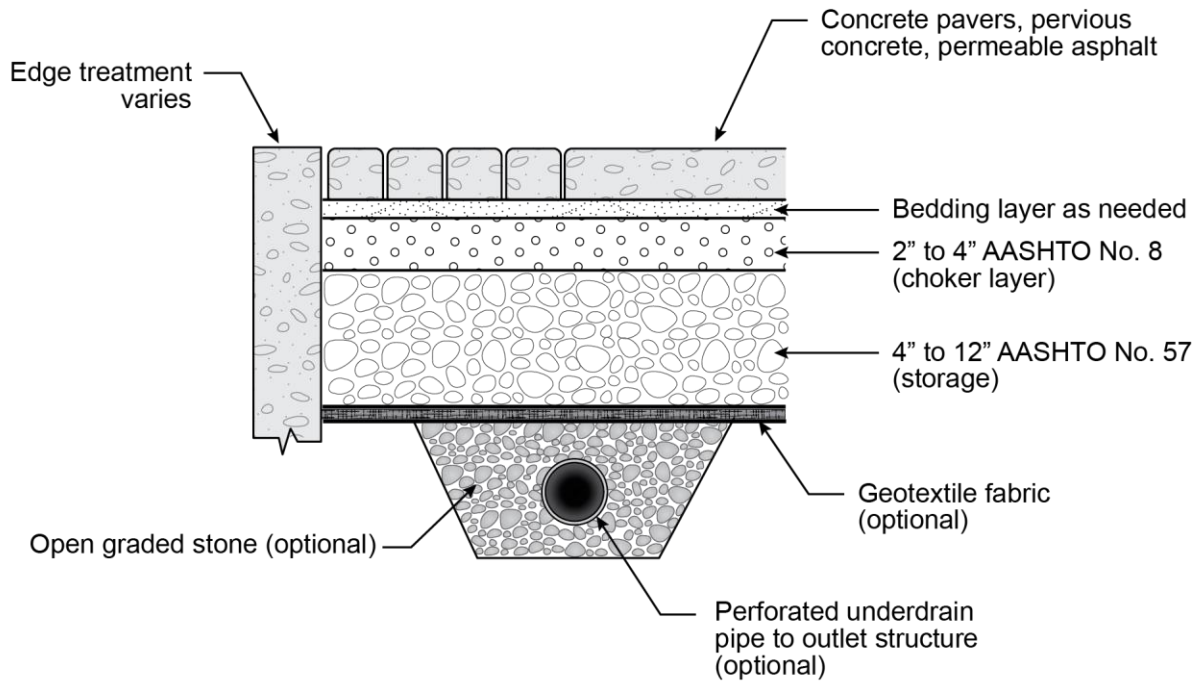

Notes:

- *Optional items shown for use of underdrain*
- *Dimensions shown may vary based on site conditions*

Pervious Surfaces

Not to scale



Infiltration Basin

ID-1



Pollutant Removal Effectiveness

Pollutant	Effectiveness
Sediment	High
Nutrients	High
Metals	High
Bacteria	High
Oil/Grease	High

Infiltration basins are shallow depressions that use existing soils to retain and provide treatment for storm water runoff. Infiltration basins function by capturing and infiltrating runoff over a specified drawdown time.

The primary functions of infiltration basins are bioretention, volume retention, and filtration. The existing soils remove pollutants through physical, chemical, and biological processes before the storm water reaches the groundwater. Filtration occurs as runoff interacts with grass and other vegetation within the basin and as runoff infiltrates through the soil.

Infiltration basins are typically designed for larger drainage areas where it may be impractical for a BMP such as a bioretention area that requires more maintenance of specialized vegetation over a larger area.

Pretreatment of runoff may take place in a forebay that will allow for particulate settling. Forebays are typically sized for a percentage of the water quality volume; typically ranging from 10% to 25%.

Primary Functions	
Bioretention	Yes
Volume Retention	Yes
Biofiltration	Yes

Design Criteria

Refer to *Design Criteria* in the *Preface to Fact Sheets* for discussion of design criteria parameters.

Parameter	Min. Value	Max. Value	Notes
Water Quality Volume	0.1 ac-ft (4356 cf)	No maximum	-
Freeboard	1 ft		-
Overflow Spillway Length	3 ft spillway length		-
Invert Slope	0% (flat basin bottom)		-
Interior Side Slopes	No minimum	3H:1V	-
Drawdown Time	24 hours	72 hours	48 hours recommended
Design Infiltration Rate	0.25 in/hr	6 in/hr	Field testing required for final design.
Depth to Historical High Groundwater	2 ft	No maximum	-

Calculation Methods

Infiltration basin design is governed by the water quality volume. The general design steps are:

1. Calculate the water quality volume.
2. Determine the geometry of the infiltration basin.
3. Based on the basin geometry, determine the ponding depth required to hold the water quality volume.
4. Calculate the drawdown time.

Calculate the water quality outlet elevation.

Sample Calculations

Refer to *Calculation Methods* in the *Preface to Fact Sheets* for discussion on the equations used.

A 13.50-acre highway development routes all of its storm water to a single infiltration basin. A safety factor of 1.50 is required for infiltration design within the jurisdiction. Adjacent soils are 'A' and are part of the drainage area.

Given

Contributing drainage area: 13.50 ac

Imperviousness: 0.65

90th percentile storm depth: 0.55 in

Soil infiltration rate: 1.35 in/hr

Design Goals

Determine the bottom footprint of the infiltration basin and the elevation of the water quality outlet above the basin bottom.

Calculations

Volumetric runoff coefficient, R_V (See *Sample Calculations*)

$$R_{V-A} = 0.84i^{1.302} \text{ (} R_V \text{ based on hydrologic soil group)}$$

$$R_{V-A} = 0.84(0.65)^{1.302}$$

$$R_V = 0.48$$

Water quality volume, WQV (See *Developing the 90th Percentile Volume*)

$$WQV = (0.48)(0.55 \text{ in})(13.50 \text{ ac})(43,560 \text{ sf/ac}) / (12 \text{ in/ft})$$

$$WQV = 12,921 \text{ cf}$$

Minimum footprint, A_{min} (See *Minimum footprint area*)

$$A_{\text{min}} = (12)(1.50)(12,921 \text{ cf}) / (1.35 \text{ in/hr})(48 \text{ hrs})$$

$$A_{\text{min}} = 3,589 \text{ sf}$$

The water quality volume will infiltrate into the existing soil in 48 hours if the infiltration basin bottom is 4,276 square feet. However, this does not mean that the infiltration basin bottom is limited to 4,276 square feet.

Water quality elevation, Ele_{WQ}

The elevation of a water quality outlet above the basin bottom is determined by assuming that infiltration occurs only through the bottom of the basin and not through the sides.

$$\text{Ele}_{WQ} = WQV / A_{\text{min}}$$

$$\text{Ele}_{WQ} = 12,921 \text{ cf} / 3,589 \text{ sf}$$

$$\text{Ele}_{WQ} = 3.60 \text{ ft}$$

Infiltration Basin Effectiveness

Effective infiltration basins take advantage of open spaces for retaining and treating storm water. Established vegetation with adequate coverage is an indication of a healthy infiltration basin along with minimal sediment and lack of invasive vegetation. Side slopes should be stable and show little to no signs of erosion or rilling. Slope sloughing is an indication that geotechnical remediation is needed.

During the design storm event, infiltration basins should, at most, pond up to the water quality outlet. After the rain event, runoff within the basin should infiltrate through the bottom soils within the design drawdown time.

Designer Checklist

If the answer to these questions corresponds to a response box that is red, the BMP should either not be used or additional measures need to be taken to address the issue.

	<u>Yes</u>	<u>No</u>
Does groundwater meet the jurisdiction's minimum separation requirement?	<input type="checkbox"/>	<input style="color: red;" type="checkbox"/>
Is there available right-of-way, property, or easement for the infiltration basin?	<input type="checkbox"/>	<input style="color: red;" type="checkbox"/>
Is contaminated groundwater present at the infiltration basin location?	<input style="color: red;" type="checkbox"/>	<input type="checkbox"/>
Is the water quality volume above the 4,356 cf threshold?	<input type="checkbox"/>	<input style="color: red;" type="checkbox"/>

Does the infiltration basin provide storage for 100% of the water quality volume? (If no, it may still be appropriate to construct the infiltration basin if it is technically infeasible to capture 100% of the water quality volume.)	<input type="checkbox"/>	<input type="checkbox"/>
Do utility conflicts make installation of the infiltration basin technically infeasible?	<input type="checkbox"/>	<input type="checkbox"/>
Do geotechnical conditions exist that compromise the stability of the infiltration basin or surrounding structures?	<input type="checkbox"/>	<input type="checkbox"/>
Does an overflow outlet structure or bypass mechanism exist?	<input type="checkbox"/>	<input type="checkbox"/>
Is a fence required?	<input type="checkbox"/>	<input type="checkbox"/>

Vegetation

Refer to [Vegetation Guidance by BMP Type](#).

Installation

Excavation

Installation of infiltration basins is a relatively straightforward process of excavation and grading; however, the basin will fail if proper care is not taken during construction. Excavators and heavy machinery should not be used within the basin area to avoid soil compaction.

Activities During Construction

Avoid using heavy machinery within the infiltration basin footprint during construction as doing so will compact the soils and diminish their infiltrating capabilities. Installation of an outlet structure may require machinery.

Flows During Construction

Flows during construction should be diverted away from the infiltration basin to prevent construction site sediment from clogging soils. Seeding or laying turf sod should occur within a short time span after excavation to minimize the impact of unnecessary storm water flows from entering the basin area. The introduction of unwanted sediment can be prevented by placing fiber rolls or silt fences around the basin perimeter during construction.

Additional Guidance

- Require certificates of compliance to verify that construction items meet specification requirements.
- Follow landscaping guidance to ensure that vegetation establishes after installation.

Installation Costs

The following cost items are typically associated with infiltration basin construction.

- Excavation
- Grading
- Outlet structure or upstream bypass structure (for larger storm events)
- Forebay and associated items: outlet protection, forebay wall, and connection between forebay and main bay.

Maintenance

Refer to *Maintenance* and *Maintenance Costs* in the *Preface to Fact Sheets* for general information related to maintenance of infiltration BMPs.

Maintenance Activities

Inspection	Inspection/Maintenance Frequency	Maintenance Activity	Effort
Inspect for trash and debris at inlet and outlet structures.	Semiannual (Spring, Fall) or as needed	Remove and dispose of trash and debris.	LOW
Inspect grass length.	As needed	Mow basin grass.	LOW
Inspect pre-treatment diversion structures for sediment build-up.	Semiannual (Spring, Fall)	Remove and dispose of sediment buildup.	LOW
Inspect topsoil for sediment buildup.	Semiannual (Spring, Fall) or as needed	Remove sediment.	LOW
Inspect for standing water above trench or within observation well (if used).	Semiannual (Spring, Fall)	Notify engineer for further inspection.	LOW

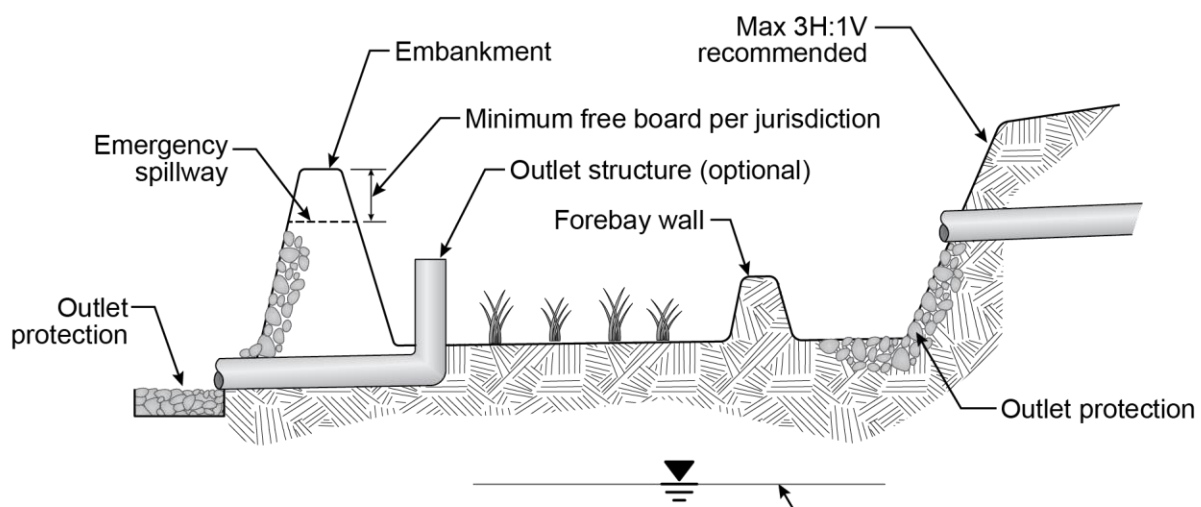
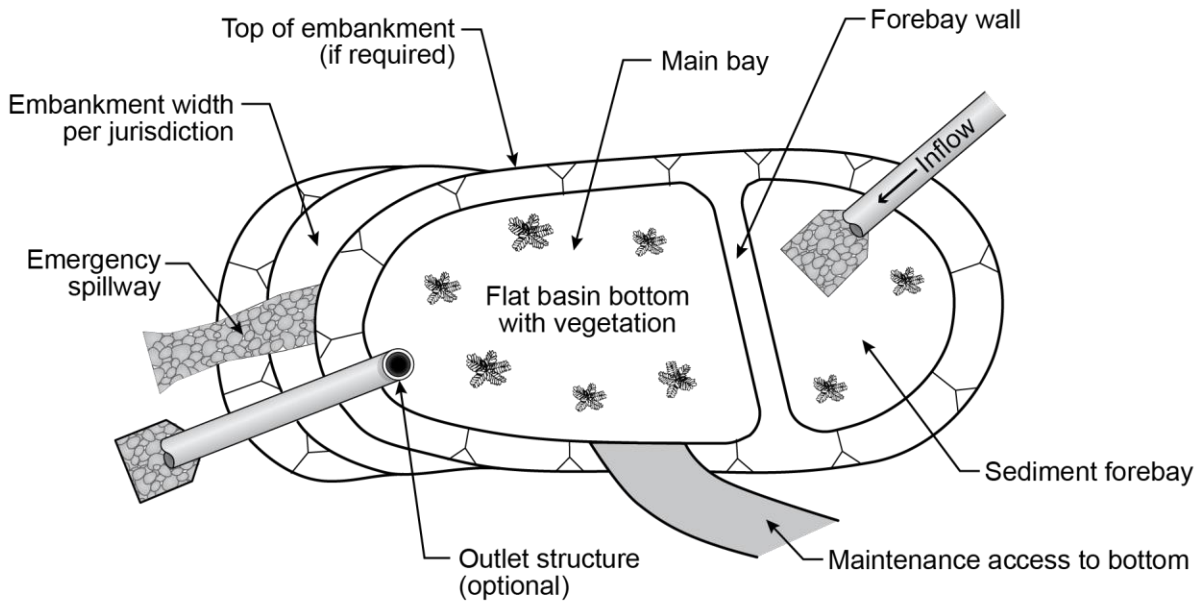

Notes:

- Dimensions shown may vary based on site conditions
- Forebay connection type to main bay will vary: outlet pipe, gabion wall, notched concrete wall, and others are acceptable
- Consider upstream bypass for large storm events

Infiltration Basin

Not to scale



Infiltration Trench

ID-2



Source: NHDES Soak Up the Rain

Infiltration trenches are linear excavations that are backfilled with a combination of gravel, open graded stone, and sand layers that provide storage within the pore space of the specified layers. Although typically linear, infiltration trenches can be any shape provided that the footprint and depth are sized to retain the water quality volume.

The primary function of infiltration trenches is volume retention. The trench is designed such that the water quality volume is retained and stored within the gravel and sand layers. Depending on the design of the trench, pollutant removal occurs via filtration as runoff passes through an initial pea gravel layer and ultimately through the bottom sand layer. A geotextile fabric is also recommended along the sidewalls of the trench and under the pea gravel layer.

Pollutant Removal Effectiveness

Pollutant	Effectiveness
Sediment	High
Nutrients	High
Metals	High
Bacteria	High
Oil/Grease	High

Primary Functions	
Bioretention	Yes ¹
Volume Retention	Yes
Biofiltration	Some

¹Bioretention occurs in subsurface and not within the trench.

Design Criteria

Refer to *Design Criteria* in the *Preface to Fact Sheets* for discussion of design criteria parameters.

Parameter	Min. Value	Max. Value	Notes
Depth of Trench	2 ft	No maximum	Maximum depth determined by jurisdiction.
Longitudinal Trench Slope	0%	1%	-
Width	2 ft	No maximum	-
Drawdown Time	12 hours	72 hours	-
Design Infiltration Rate	0.25 in/hr	6 in/hr	Field testing required for final design.
Depth to Historical High Groundwater	2 ft	No maximum	-

Calculation Methods

Infiltration trench design is governed by the water quality volume. The general design steps are:

1. Calculate the water quality volume.
2. Determine the trench footprint.
3. Based on the trench geometry, porosity of the trench layers, and ponding depth (if any), determine the trench depth.
4. Calculate the drawdown time.

Sample Calculations

Refer to *Calculation Methods* in the *Preface to Fact Sheets* for discussion on the equations used.

A proposed park will have a concrete plaza that is 0.40 acres. Runoff from the plaza will flow towards a pervious area. To meet the jurisdiction's retention requirement, the design team proposes to install an infiltration trench adjacent to the plaza.

Given

Contributing drainage area: 0.40 ac

Imperviousness: 1.00

90th percentile storm depth: 0.70 in

Design Goals

Determine that the geometry of an infiltration trench that will retain the water quality volume.

Calculations

Volumetric runoff coefficient, R_V (See *Sample Calculations*)

$$R_V = 0.91i - 0.0204 \text{ (Reese method)}$$

$$R_V = 0.91(1.0) - 0.0204$$

$$R_V = 0.89$$

Water quality volume, WQV (See *Developing the 90th Percentile Volume*)

$$WQV = (0.89)(0.70 \text{ in})(0.40 \text{ ac})(43,560 \text{ sf/ac}) / (12 \text{ in/ft})$$

$$WQV = 904 \text{ cf}$$

There are 100 linear feet adjacent to the plaza that are available for the infiltration trench. Based on the grading at the trench, ponding above the trench will not occur. A trench that is 4.5 ft wide with the following properties will be able to retain the water quality volume. See *Storage volume within a media with a known porosity* for guidance on determining storage within soils.

Layer	Thickness, in	Porosity	Storage Volume, cf
Pea Gravel	4	0.25	37.5
Open Graded Stone	56	0.4	840
Sand Layer	6	0.15	33.8
Total	66	0.36 (weighted)	911.2

The equivalent storage depth of the water quality volume within the 4,500-sf infiltration trench is:

$$d = 911.2 \text{ cf} / 4,500 \text{ sf}$$

$$d = 2 \text{ ft}$$

$$d = 24 \text{ in}$$

Drawdown time, t

The infiltration rate of the surrounding soils is 1.5 in/hr.

$$t = \text{Equivalent storage depth} / \text{infiltration rate}$$

$$t = 24 \text{ in} / 1.5 \text{ in/hr}$$

$$t = 16 \text{ hrs}$$

Infiltration Trench Effectiveness

Effective infiltration trenches take advantage of limited or narrow spaces where bioretention areas or infiltration basins are impractical. Visible sediment buildup on the top layer of the trench could be an indication that clogging is present within the trench or that runoff is simply passing over the trench and not being captured. Although some vegetation intrusion or organic debris is likely not a concern, proper grooming and maintenance will contribute to a trench’s extended life-span.

During the design storm event, runoff should be conveyed toward and enter the trench per the design plans. Recent new construction, regrading, or resurfacing within the contributing drainage area should be noted as it may impact flow paths or the introduction of new pollutants.

Designer Checklist

If the answer to these questions corresponds to a response box that is red, the BMP should either not be used or additional measures need to be taken to address the issue.

	<u>Yes</u>	<u>No</u>
Does groundwater meet the jurisdiction’s minimum separation requirement?	<input type="checkbox"/>	<input type="checkbox"/>
Is the infiltration rate of the existing soils within acceptable rates?	<input type="checkbox"/>	<input type="checkbox"/>
Is contaminated groundwater present at the infiltration trench location?	<input type="checkbox"/>	<input type="checkbox"/>
Do utility conflicts make installation of the infiltration trench technically infeasible?	<input type="checkbox"/>	<input type="checkbox"/>
Do geotechnical conditions exist that compromise the stability of the infiltration trench or surrounding structures?	<input type="checkbox"/>	<input type="checkbox"/>
Does the infiltration trench provide storage for 100% of the water quality volume? (If no, it may still be appropriate to construct the infiltration trench if it is technically infeasible to capture 100% of the water quality volume.)	<input type="checkbox"/>	<input type="checkbox"/>
Does an overflow outlet structure or bypass mechanism exist, if needed?	<input type="checkbox"/>	<input type="checkbox"/>

Vegetation

Vegetation is not typical for an infiltration trench.

Installation

Excavation

Excavation for infiltration trenches is typically linear but alternate geometries are possible. During excavation, light machinery should be used to avoid excessive compaction.

Activities During Construction

Avoid using heavy machinery within the infiltration trench footprint during construction as doing so will compact the soils and diminish their infiltrating capabilities.

Flows During Construction

Flows during construction should be diverted away from the infiltration trench to prevent construction site sediment from clogging soils. The introduction of unwanted sediment can be prevented by placing fiber rolls or silt fences around the trench perimeter during construction.

Additional Guidance

- Require certificates of compliance to verify that construction items meet specification requirements.

Installation Costs

The following cost items are typically associated with infiltration trench construction.

- Excavation
- Landscaping and vegetation
- Pea gravel
- Open graded stone
- Sand layer
- Geotextile separator

Maintenance

Refer to *Maintenance* and *Maintenance Costs* in the *Preface to Fact Sheets* for general information related to maintenance of infiltration BMPs.

Maintenance Activities

Inspection	Inspection/Maintenance Frequency	Maintenance Activity	Effort
Inspect for trash and debris at inlet and outlet structures.	Semiannual (Spring, Fall) or as needed	Remove and dispose of trash and debris.	LOW
Inspect grass length, if any, on top of trench.	As needed	Mow trench grass.	LOW
Inspect pre-treatment diversion structures for sediment buildup.	Semiannual (Spring, Fall) or as needed	Remove and dispose of sediment build up.	LOW
Inspect tree growth near trench.	Semiannual (Spring, Fall)	Remove trees in vicinity of the trench.	LOW
Inspect for standing water above trench or within observation well.	Semiannual (Spring, Fall)	Notify engineer for further inspection.	LOW

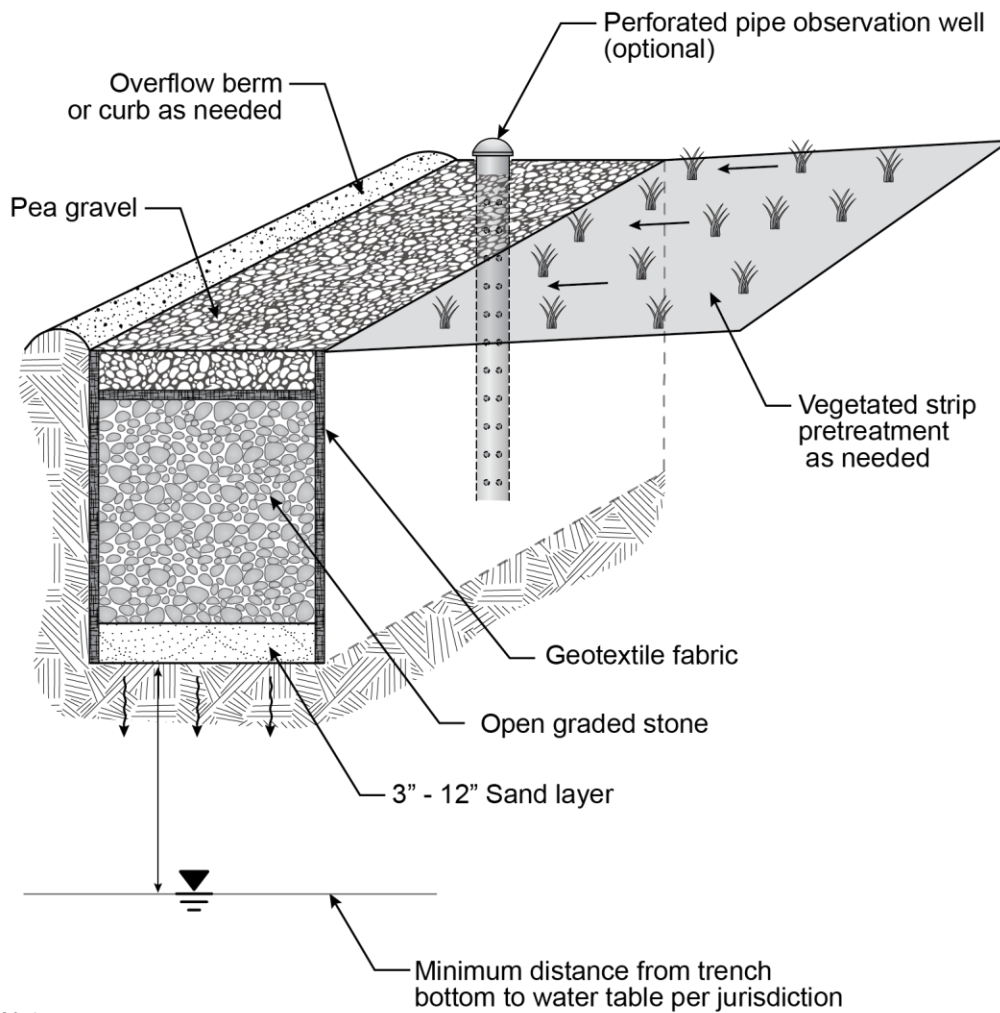

Notes:

- Dimensions shown may vary based on site conditions

Infiltration Trench

Not to scale



Dry Well

ID-3



Pollutant Removal Effectiveness

Pollutant	Effectiveness
Sediment	High
Nutrients	High
Metals	High
Bacteria	High
Oil/Grease	High

Dry wells are underground storage areas that are sized to retain the water quality volume and infiltrate runoff into the existing soils.

The primary functions of dry wells are bioretention and volume retention. Bioretention does not occur within the dry well but occurs in the native soils immediately surrounding the dry well.

Dry wells contribute to aquifer recharge and as such classify as a subclass of Underground Injection Control (UIC) Class V wells. Refer to the DWQ website on storm water drainage wells (link below) for more information relating to the UIC Program.

Primary Functions	
Bioretention	Yes
Volume Retention	Yes
Biofiltration	No

Storm Water Drainage Wells: <https://deq.utah.gov/legacy/programs/water-quality/utah-underground-injection-control/drainage-wells/index.htm>

Design Criteria

Refer to *Design Criteria* in the *Preface to Fact Sheets* for discussion of design criteria parameters.

Parameter	Min. Value	Max. Value	Notes
Depth to Historical High Groundwater	2 ft	No maximum	-
Drawdown Time	24 hours	72 hours	-
Building Setback	10 ft	No maximum	-
Design Infiltration Rate	0.25 in/hr	6 in/hr	Field testing required for final design.

Calculation Methods

Dry well design is governed by the water quality volume. The general design steps are:

1. Calculate the water quality volume.
2. Determine the dry well geometry.
3. Determine the drawdown time.

Sample Calculations

Refer to *Calculation Methods* in the *Preface to Fact Sheets* for discussion on the equations used.

A drywell is proposed at the downstream end of a swale that is being proposed adjacent to a new road.

Given

Contributing drainage area: 0.72 ac

Imperviousness: 0.40

90th percentile storm depth: 0.59 in

Infiltration rate of surrounding soil: 3 in/hr

Design Goals

Determine the dry well geometry required to hold the water quality volume.

Calculations

Volumetric runoff coefficient, R_V (See *Sample Calculations*)

$$R_V = 0.225i + 0.05 \text{ (Granato method when } i < 0.55)$$

$$R_V = 0.225(0.40) + 0.05$$

$$R_V = 0.14$$

Water quality volume, WQV (See *Developing the 90th Percentile Volume*)

$$WQV = (0.14)(0.59 \text{ in})(0.72 \text{ ac})(43,560 \text{ sf/ac}) / (12 \text{ in/ft})$$

$$WQV = 220 \text{ cf}$$

A dry well that has a 6 ft radius and is 8 ft deep will hold 226 cf.

For a conservative estimate at the planning stage, the dry well’s drawdown time is based on the infiltration rate of the surrounding soil and ignores the effects of the pressure head within the dry well. A more detailed determination of the drawdown should be done for final design.

Drawdown time, t

t = Dry well depth / infiltration rate

t = (8 ft)(12 in/ft) / 3 in/hr

t = 32 hrs

Dry Well Effectiveness

Effective dry wells optimize infiltrating soils within limited space to retain storm water runoff while not introducing stability concerns to nearby development or structures. The design storm volume within a functioning dry well will drawdown within the design time and leave no standing water inside of the well. Pretreatment should be provided prior to entering the dry well and the pretreatment method should be determined based on the expected pollutants. Entry to the dry well should be unobstructed and free of debris that will restrict flows from entering.

Designer Checklist

If the answer to these questions corresponds to a response box that is red, the BMP should either not be used or additional measures need to be taken to address the issue.

	<u>Yes</u>	<u>No</u>
Does groundwater meet the jurisdiction’s minimum separation requirement?	<input type="checkbox"/>	<input type="checkbox"/>
Is the infiltration rate of the existing soils within acceptable rates?	<input type="checkbox"/>	<input type="checkbox"/>
Is contaminated groundwater present at the dry well location?	<input type="checkbox"/>	<input type="checkbox"/>
Do utility conflicts make installation of the dry well technically infeasible?	<input type="checkbox"/>	<input type="checkbox"/>
Do geotechnical conditions exist that compromise the stability of the dry well or surrounding structures?	<input type="checkbox"/>	<input type="checkbox"/>
Is pretreatment provided upstream of or within the dry well?	<input type="checkbox"/>	<input type="checkbox"/>

Installation

Excavation

Excavate area in which dry well will be placed.

Activities During Construction

Take proper safety measures to cover the excavated dry well area before putting the dry well in place. If the dry well is designed to infiltrate through the well bottom, place and level gravel within the excavation to provide a foundation for the well structure.

Flows During Construction

Flows during construction can enter the dry well if the grated manhole lid contains a filtering material.

Additional Guidance

- Require certificates of compliance to verify that construction items meet specification requirements.
- Obtain a permit through the UIC Program

Installation Costs

The following cost items are typically associated with dry well construction.

- Excavation
- Dry well
- Permit application fees for Class V Injection Wells
- Gravel-filled annular space surrounding dry well
- Pretreatment upstream of dry well
- Overflow connection to downstream system
- Gravel foundation (optional)

Maintenance

Refer to *Maintenance* and *Maintenance Costs* in the *Preface to Fact Sheets* for general information related to maintenance of dry wells.

Maintenance Activities

Inspection	Inspection/Maintenance Frequency	Maintenance Activity	Effort
Inspect water depth.	Initially after every major storm, then annually.	Remove and dispose of built up sediment when buildup causes reduction in detention capacity. Notify the engineer.	Medium
Inspect inlet for obstructions.	Semiannual (Spring, Fall) or as needed	Remove obstructions.	LOW
Inspect structural elements.	As determined by jurisdiction.	Repair or reconstruct deficient structural components.	Medium

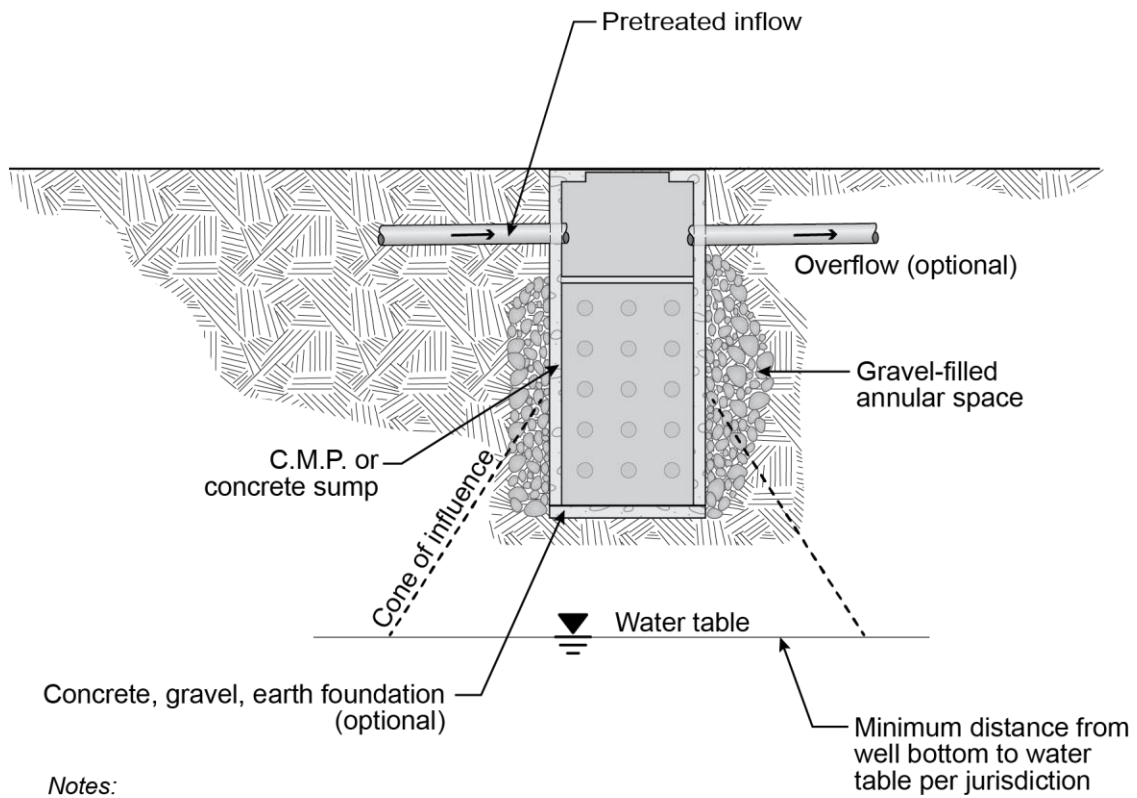

Notes:

- *Dimensions shown may vary based on site conditions*

Dry Well

Not to scale



Underground Infiltration Galleries

ID-4



Source: StormTech

Pollutant Removal Effectiveness

Pollutant	Effectiveness
Sediment	High
Nutrients	High
Metals	High
Bacteria	High
Oil/Grease	High

Underground storage devices are proprietary alternatives to above ground storage when space at the project site is limited. They may be sized for the 90th percentile volume similar to how they are sized for flood control volumes. When underground storage is used for water quality, its primary functions are bioretention as runoff infiltrates into the underlying soil and volume retention. They are constrained by subsurface conditions such as depth to the historical high groundwater, soil infiltration rates, and other site-specific constraints that prevent infiltration. Designing underground storage devices is done with the assistance of the device manufacturer.

Pretreatment for underground systems will vary. Pretreatment removes sediment that will potentially clog elements of the underground system such as geotextile fabrics or bedding layers. If the manufacturer does not include a pretreatment system as part of the device, it may be necessary to design a separate pretreatment system such as a settling basin upstream before entering the underground system.

Primary Functions	
Bioretention	Yes
Volume Retention	Yes
Biofiltration	No

Underground systems are typically modular and allow for configurations that range from large areas such as would be needed underneath a parking lot to linear installations like within a park strip or underneath a bioswale.

Design Criteria

Underground storage devices are proprietary devices; follow manufacturer specifications to determine design criteria on a case-by-case basis.

Calculation Methods

Underground storage device design is governed by the water quality volume (when sizing for the water quality event). It is not uncommon for manufacturers to provide sizing tools based on the desired storage volume. The general design steps are:

1. Calculate the water quality volume.
2. Determine manufacturer's recommendations given the water quality volume and other site conditions.

Underground Infiltration Effectiveness

With regular maintenance and inspection, it can be determined if the underground system is performing as expected. As part of the design process, determine how the system will be inspected. Possible inspection methods include the use of observation wells or structural vaults at tie-in locations with the site's storm drain network. Inspect for any soil displacement or movement at the perimeter of the system and any depressions above the system.

Designer Checklist

If the answer to these questions corresponds to a response box that is red, the BMP should either not be used or additional measures need to be taken to address the issue.

	<u>Yes</u>	<u>No</u>
Does groundwater meet the jurisdiction's minimum separation requirement?	<input type="checkbox"/>	<input type="checkbox"/>
Is the infiltration rate of the existing soils within acceptable rates?	<input type="checkbox"/>	<input type="checkbox"/>
Is contaminated groundwater present?	<input type="checkbox"/>	<input type="checkbox"/>
Do utility conflicts exist that make installation of the device technically infeasible?	<input type="checkbox"/>	<input type="checkbox"/>
Do geotechnical conditions exist that compromise the stability of the device or surrounding structures?	<input type="checkbox"/>	<input type="checkbox"/>
Is pretreatment provided upstream of or within the underground storage device?	<input type="checkbox"/>	<input type="checkbox"/>
Is the soil bearing capacity of the underlying soil sufficient for the system?	<input type="checkbox"/>	<input type="checkbox"/>
Will the underground system support the expected loads above it?	<input type="checkbox"/>	<input type="checkbox"/>

Installation

Excavation

Excavate the footprint of the underground system.

Activities During Construction

Avoid using heavy machinery within the excavated footprint during construction as doing so will compact the soils and diminish their infiltrating capabilities. Avoid using heavy machinery on top of the underground system as well. Follow all installation guidelines from the manufacturer.

Flows During Construction

Flows during construction should be diverted away from the excavated area to prevent construction site sediment from clogging soils.

Additional Guidance

- Follow all manufacturer’s requirements.

Installation Costs

The following cost items are typically associated with installation of underground storage systems.

- Excavation
- Geotextile fabric
- Underground storage devices
- Aggregate (bedding, overlay, other as needed)
- Observation wells
- Pretreatment upstream of system (if not provided)

Maintenance

Underground systems are typically designed with accessible pretreatment areas such as a manhole. Refer to manufacturer’s guidelines.

Maintenance Activities

Typical maintenance activity includes removal of sediment or debris within the pretreatment area. High pressure washing of geotextile fabrics or replacement of filter fabrics may also be needed. Refer to manufacturer’s guidelines for specific activities and frequency of inspections.

Manufacturers

The following table of manufacturers is for reference only and does not constitute an endorsement.

<u>Manufacturer</u>	<u>Device Type(s)</u>	<u>URL</u>
StormTech	Chambers	http://www.stormtech.com/
ACF Environmental	Chambers R Tanks	https://www.acfenvironmental.com
ConTech	Chambers	https://www.conteches.com

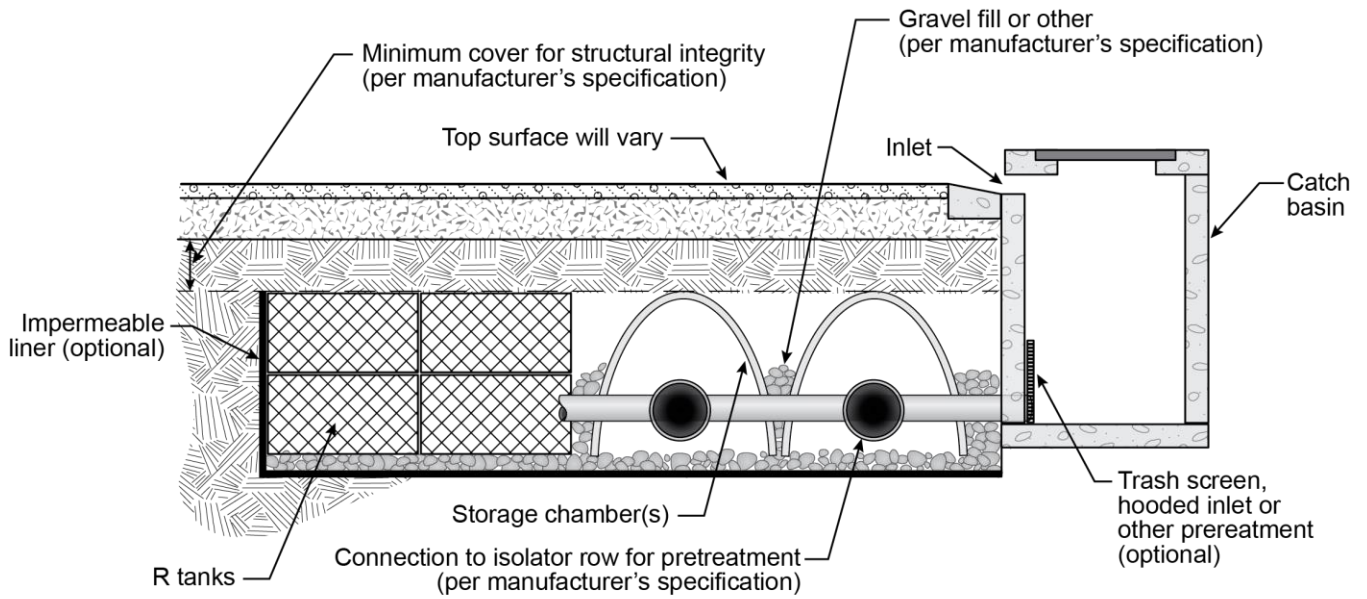

Notes:

- Configurations will vary
- Impermeable liner around underground system if groundwater concerns exist
- If impermeable liner is used, provide outlet to prevent standing water

Underground Infiltration Gallery

Not to scale



Harvest and Reuse

HR-1



Pollutant Removal Effectiveness
 Pollutant removal will vary based on the ultimate use of the harvested runoff.

Harvest and reuse refers to any type of runoff collection system that captures rainfall, stores it temporarily, and reuses it for irrigation, landscaping, or other non-potable uses. Harvest and reuse systems inherently retain the volume of runoff that it captures. Depending on the subsequent use after being captured, they also provide bioretention and filtration to the released runoff.

Harvest and reuse systems may be used in lieu of directly connecting rooftop drains to storm sewer systems; where downdrains discharge to impervious surfaces and the opportunity for irrigation or landscaping exists; as part of a home owner’s irrigation plan; or for any other non-potable purpose where storm water is determined to be acceptable such as vehicle or machinery washing.

As of 2010, Utah’s legislative code [73-3-1.5](#) requires that if more than 100 gallons of rainwater (13.4 cf) are captured, it must be registered through the Utah Division of Water Rights (<https://waterrights.utah.gov/forms/rainwater.asp>). The code also limits the total capture to 2,500 gallons (334.2 cubic feet). See the code for additional requirements.

Primary Functions	
Bioretention	Varies
Volume Retention	Yes
Biofiltration	Varies

Design Criteria

Design criteria for harvest and reuse devices or systems will vary widely. The governing principles of harvest and reuse are based on the system's function and capacity. For example, a rain barrel that provides occasional irrigation to a flower bed should be appropriately sized for the 90th percentile volume and be able to release the volume within an appropriate time that does not flood out the flower bed. A larger harvest and reuse system, such as an underground detention vault or above ground pond will be required to meet geotechnical or structural design criteria. The applications of harvest and reuse systems are endless; specific design criteria should be determined on a case-by-case basis with site-specific consideration.

Calculation Methods

Harvest and reuse systems are governed by the water quality volume. The general design steps are:

1. Calculate the water quality volume.
2. Size device for the water quality volume.

Sample Calculations

Refer to [Calculation Methods](#) in the [Preface to Fact Sheets](#) for discussion on the equations used.

A commercial development will have two buildings with roofs that are 2,500 square feet each. Rain barrels that will release to flower beds will be included as part of the design. Each roof is considered one drainage area.

Given

Contributing drainage area: 2,500 sf

Contributing drainage area: 0.057 ac

Imperviousness: 1.00

90th percentile storm depth: 0.60 in

Design Goals

Capture all runoff from the 90th percentile storm within rain barrels.

Calculations

Volumetric runoff coefficient, R_V (See [Sample Calculations](#))

$$R_V = 0.91i - 0.0204 \text{ (Reese method)}$$

$$R_V = 0.91(1.0) - 0.0204$$

$$R_V = 0.89$$

Water quality volume, WQV (See [Developing the 90th Percentile Volume](#))

$$WQV = (0.89)(0.60 \text{ in})(0.057 \text{ ac})(43,560 \text{ sf/ac}) / (12 \text{ in/ft})$$

$$WQV = 111 \text{ cf}$$

$$WQV = 832 \text{ gallons}$$

If 55-gallon rain barrels are used, 15 rain barrels will be needed for each roof and the capture will need to be registered with the Division of Water Rights.

Harvest and Reuse Effectiveness

The effectiveness of a harvest and reuse system is dependent on its use. Detention devices should be free of standing water to prevent stagnation and vector concerns. Systems that provide irrigation or that are part of landscaping features should be inspected regularly to ensure proper performance.

Designer Checklist

If the answer to these questions corresponds to a response box that is red, the BMP should either not be used or additional measures need to be taken to address the issue.

	<u>Yes</u>	<u>No</u>
Will stagnation of runoff be prevented by frequent release of the harvested runoff?	<input type="checkbox"/>	<input style="border: 1px solid red;" type="checkbox"/>
Does quantity of harvested runoff require registration with the Division of Water Rights?	<input type="checkbox"/>	<input type="checkbox"/>

Installation

Installation of harvest and reuse systems will vary depending on its use. Rain barrels can simply be connected to a down drain. More complicated systems require additional coordination.

Depending on the quantity of runoff being harvested, it will be necessary to register the detention device with the Division of Water Rights.

Installation Costs

The following cost items are typically associated with harvest and reuse systems.

- Detention device
- Upstream connection to detention device
- Other items will be dependent on site-specific use

Maintenance

Refer to *Maintenance* and *Maintenance Costs* in the *Preface to Fact Sheets* for general information related to maintenance of harvest and reuse systems.

Maintenance Activities

Inspection	Inspection/Maintenance Frequency	Maintenance Activity	Effort
Inspect for mosquitos.	Semiannual (Spring, Fall)	Implement larvicide or other remediation.	LOW
Inspect harvesting device for leaking.	Semiannual (Spring, Fall)	Replace harvesting device.	LOW
Inspect condition of system components.	Semiannual (Spring, Fall)	Replace and repair components.	Medium

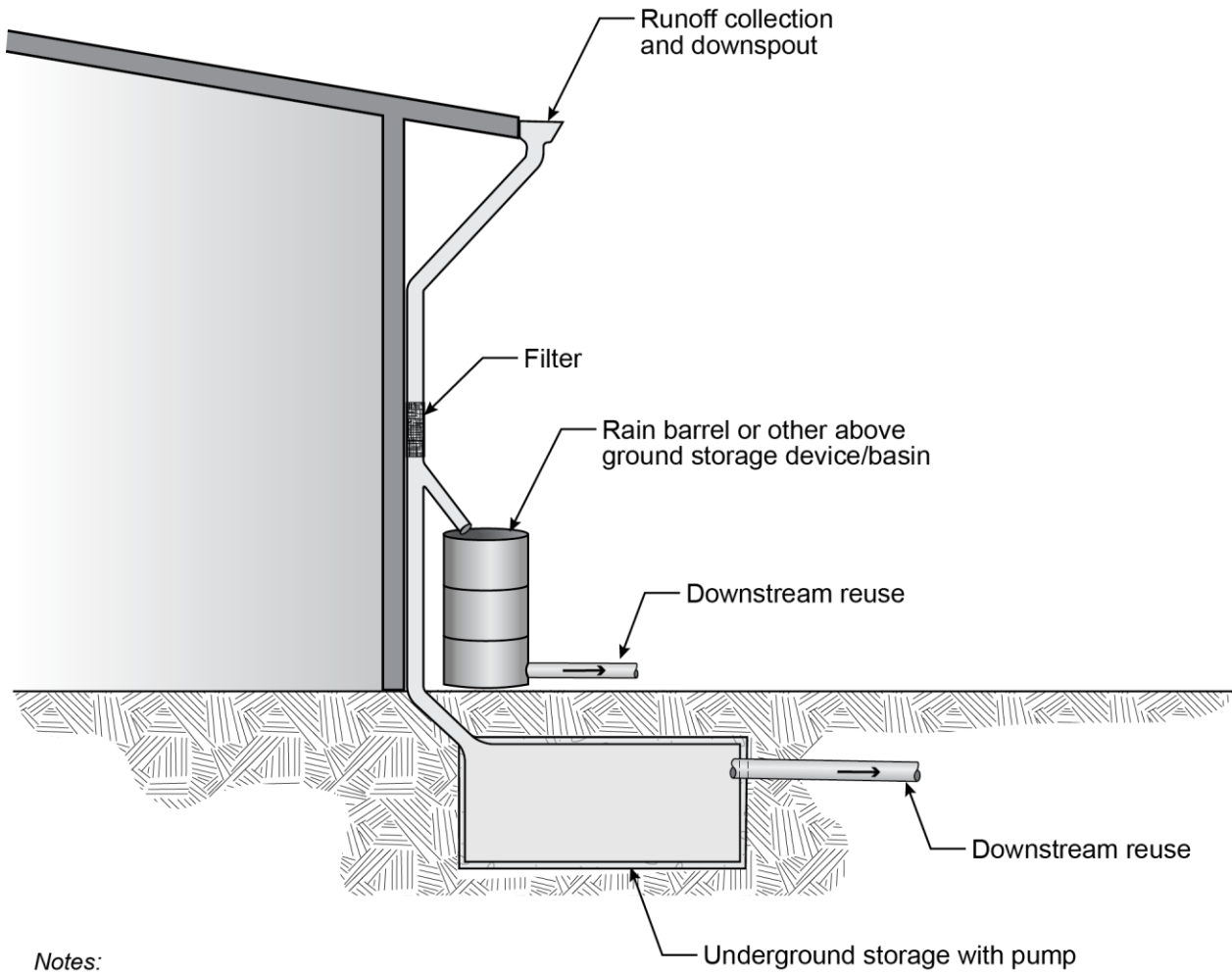

Notes:
 • Configurations and applications may vary

Harvest and Reuse

Not to scale

Appendix D Utah Plant Hardiness Zones

Plant Hardiness Zones

Source Data:
Plant Hardiness Zone, USDA 2018;
County Boundaries, Roads, USGS 2018

NEVADA

IDAHO







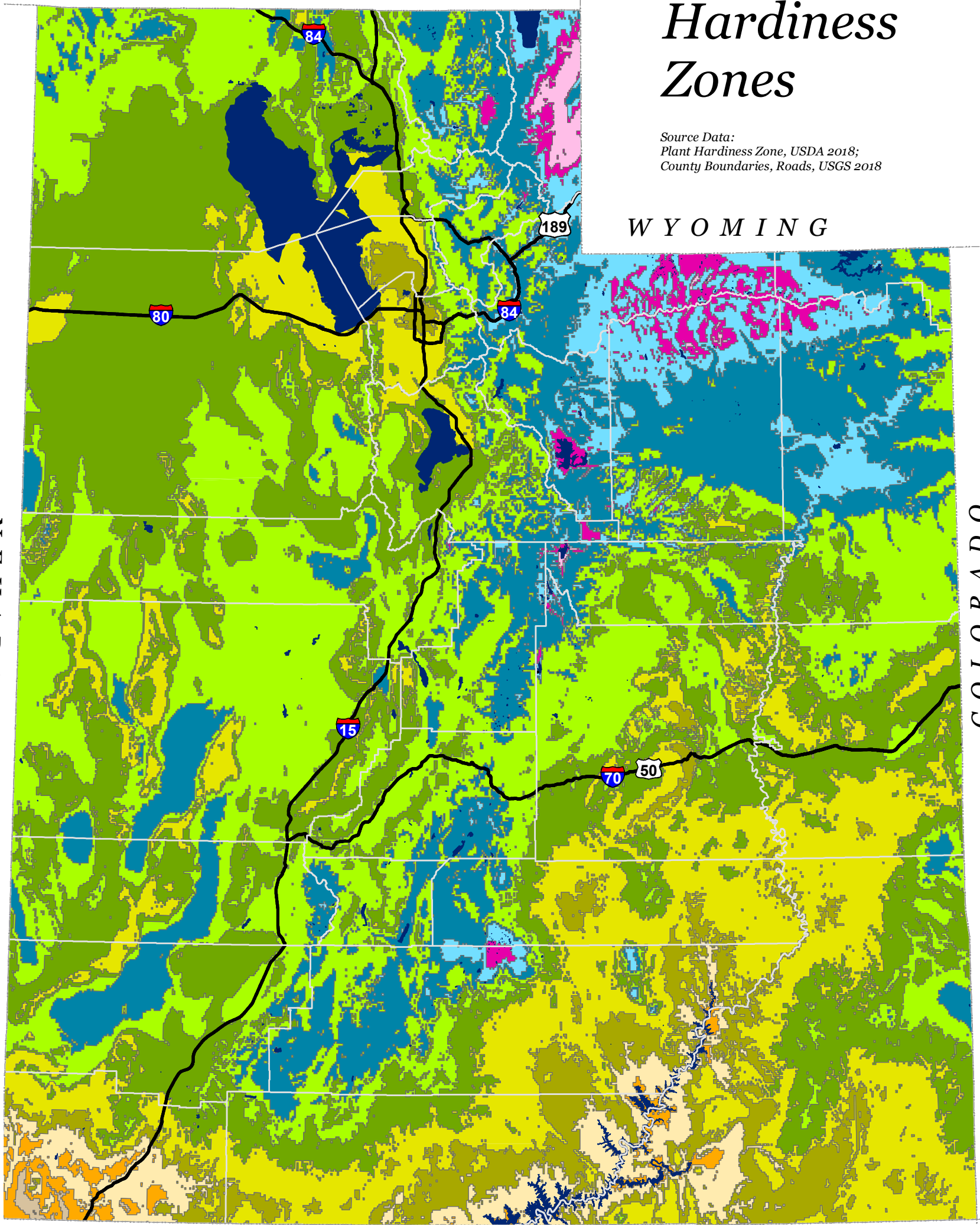







WYOMING

COLORADO

ARIZONA



HARDINESS ZONE

 3b: -35 to -30 F	 5a: -20 to -15 F	 7a: 0 to 5 F	 9a: 20 to 25 F
 4a: -30 to -25 F	 6a: -10 to -5 F	 8a: 10 to 15 F	 Lake/Pond
 4b: -25 to -20 F	 6b: -5 to 0 F	 8b: 15 to 20 F	
	 5b: -15 to -10 F	 7b: 5 to 10 F	 9b: 25 to 30 F

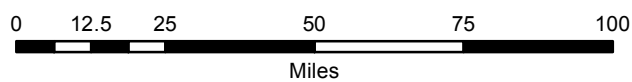

Appendix E Utah Plant Selection Matrix by Climate Zone and BMP

Plants	Zones														Best Management Practices (BMPs)							
	3b	4a	4b	5a	5b	6a	6b	7a	7b	8a	8b	9a	9b	Basin Bottom	Basin Edge	Basin Upland	Swales	Strips	Bioretention Cells/ Rain Gardens	Tree Box Filters	Green Roofs	
Trees																						
<i>Picea pungens</i> 'Mesa Verde'	Mesa Verde Spruce	x	x	x	x	x	x	x	x	x	x	x					x					
<i>Picea pungens</i> 'The Blues'	The Blues Blue Spruce																x					
<i>Picea pungens</i> var. <i>glauca</i> 'MonWal'	Sparkler Colorado Blue Spruce	x	x	x	x	x	x	x	x	x	x	x					x					
<i>Pinus mugo</i>	Mugo Pine	x	x	x	x	x	x	x	x	x							x	x				x
<i>Pinus mugo fastigiata</i> 'Wells Dolly's Choice'	Wells Dolly's Choice Mugo Pine	x	x	x	x	x	x	x	x	x												x
<i>Pinus mugo</i> 'Carsten's Wintergold'	Carsten's Wintergold Mugo Pine	x	x	x	x	x	x	x	x	x							x	x				x
<i>Pinus mugo</i> 'Jakobsen'	<i>Pinus mugo</i> 'Jakobsen'	x	x	x	x	x	x	x	x	x							x	x				x
<i>Pinus nigra</i>	Austrian Pine				x	x	x	x	x	x	x	x					x					x
<i>Pinus nigra</i> 'Arnold Sentinel'	Arnold Sentinel Austrian Pine		x	x	x	x	x	x	x	x	x	x										x
<i>Pinus ponderosa</i>	Ponderosa Pine	x	x	x	x	x	x	x	x	x							x	x				x
<i>Pinus strobus</i> 'Blue Shag'	Blue Shag Eastern White Pine		x	x	x	x	x	x	x	x	x						x	x				
<i>Pinus sylvestris</i>	Scots Pine	x	x	x	x	x	x	x	x	x	x											x
<i>Pseudotsuga menziesii</i>	Douglas Fir		x	x	x	x	x	x									x					
<i>Thuja occidentalis</i>	American Arborvitae	x	x	x	x	x	x	x	x	x				x	x	x	x	x				x
<i>Thuja occidentalis</i> 'Hetz Midget'	Hetz Midget Arborvitae	x	x	x	x	x	x	x	x	x				x	x	x						x

Plant Select, 2018; Conservation Garden Park, 2018; Charter Township of Canton, 2006; USDA-Natural Resources Conservation Service, 2000; Missouri Botanical Garden, 2018;

Plants For A Future, 2018; Monrovia, 2018; Growing Green Guide, 2018; Central Coast Low Impact Development Initiative; San Francisco Water Power Sewer, 2016

Plants		Zones												Best Management Practices (BMPs)									
Grasses		3b	4a	4b	5a	5b	6a	6b	7a	7b	8a	8b	9a	9b	Basin Bottom	Basin Edge	Basin Upland	Swales	Strips	Bioretenti on Cells/ Rain Gardens	Tree Box Filters	Green Roofs	
		Miscanthus sinensis 'Cabaret'	Cabaret Japanese Silver Grass				X	X	X	X	X	X	X	X	X	X	X	X	X	X	X	X	
Miscanthus sinensis 'Gold Bar'	Gold Bar Maiden Grass				X	X	X	X	X	X	X	X	X	X	X	X	X	X	X	X	X		X
Miscanthus sinensis 'Gracillimus'	Gracillimus Maiden Grass				X	X	X	X	X	X	X	X	X	X	X	X	X	X	X	X	X		X
Miscanthus sinensis 'Graziella'	Graziella Maiden Grass				X	X	X	X	X	X	X	X	X	X	X	X	X	X	X	X	X		X
Miscanthus sinensis 'Silberfeder' SILVER FEATHER	Silver Feather Maiden Grass		X	X	X	X	X	X	X	X	X	X	X	X	X	X	X	X	X	X	X		X
Miscanthus sinensis 'Strictus'	Porcupine Grass				X	X	X	X	X	X	X	X	X	X	X	X	X	X	X	X	X		X
Miscanthus sinensis 'variegatus'	Variegated Maiden Grass				X	X	X	X	X	X	X	X	X	X	X	X	X	X	X	X	X		X
Miscanthus sinensis 'Punktchen' LITTLE DOT	Little Dot Maiden Grass				X	X	X	X	X	X	X	X	X	X	X	X	X	X	X	X	X		X
Miscanthus sinensis 'Morning Light'	Morning Light Maiden Grass				X	X	X	X	X	X	X	X	X	X	X	X	X	X	X	X	X		X
Miscanthus sinensis 'Yaku Jima'	Yaku Jima Maiden Grass				X	X	X	X	X	X	X	X	X	X	X	X	X	X	X	X	X		X
Miscanthus sinensis 'Zebrinus'	Zebra Grass				X	X	X	X	X	X	X	X	X	X	X	X	X	X	X	X	X		X
Muhlenbergia rigens	Deer Grass						X	X	X	X	X	X	X	X		X	X	X	X	X			
Nasella tenuissima	Mexican Feather Grass						X	X	X	X	X	X	X	X									X
Panicum virgatum	Switch Grass				X	X	X	X	X	X	X	X	X	X		X	X		X	X			
Panicum virgatum 'Dallas Blues'	Dallas Blues Switch Grass				X	X	X	X	X	X	X	X	X	X		X	X	X	X	X	X	X	
Panicum virgatum 'Cloud Nine'	Cloud Nine Switch Grass				X	X	X	X	X	X	X	X	X	X		X	X	X	X	X	X	X	
Panicum virgatum 'Heavy Metal'	Heavy Metal Switch Grass				X	X	X	X	X	X	X	X	X	X		X	X	X	X	X	X	X	
Panicum virgatum 'Prairie Sky'	Prairie Sky Switch Grass		X	X	X	X	X	X	X	X	X	X	X	X		X	X	X	X	X	X	X	
Panicum virgatum 'Rotstrahlbusch'	Red Switch Grass				X	X	X	X	X	X	X	X	X	X		X	X	X	X	X	X	X	
Panicum virgatum 'Shenandoah'	Shenandoah Switch Grass				X	X	X	X	X	X	X	X	X	X		X	X	X	X	X	X	X	
Panicum virgatum 'Strictum'	Upright Switch Grass		X	X	X	X	X	X	X	X	X	X	X	X		X	X	X	X	X	X	X	
Pennisetum alopecuroides 'Little Bunny'	Little Bunny Dwarf Fountain Grass						X	X	X	X	X	X	X	X							X	X	
Pennisetum alopecuroides 'Moudry'	Black Flowering Fountain Grass						X	X	X	X	X	X	X	X							X		
Pennisetum orientale 'Karley Rose'	Karley Rose Oriental Fountain Grass						X	X	X	X	X	X	X	X							X		
Poa pratensis	BioBlue Kentucky Bluegrass Mix				X	X	X	X	X	X	X	X	X	X	X	X	X	X	X	X	X	X	X
Schizachyrium scoparium	Little Bluestem				X	X	X	X	X	X	X	X	X	X							X	X	X
Schizachyrium scoparium 'Blaze'	Blaze Little Bluestem		X	X	X	X	X	X	X	X	X	X	X	X							X	X	X
Schizachyrium scoparium 'MinnblueA'	Blue Heaven Little Bluestem		X	X	X	X	X	X	X	X	X	X	X	X									X
Schizachyrium scoparium 'Prairie Blues'	Prairie Blues Little Bluestem		X	X	X	X	X	X	X	X	X	X	X	X							X	X	X
Schizachyrium scoparium 'Standing Ovation' PP25,202	Standing Ovation little bluestem		X	X	X	X	X	X	X	X	X	X	X	X							X	X	X
Scirpus atrovirens	Dark Green Rush		X	X	X	X	X	X	X	X	X	X	X	X			X	X					
Spartina pectinata	Prairie Cordgrass		X	X	X	X	X	X	X	X	X	X	X	X	X	X	X	X	X	X	X	X	
Sporobolus airoides	Alkali Sacaton		X	X	X	X	X	X	X	X	X	X	X	X							X	X	
Sporobolus wrightii	Giant sacaton				X	X	X	X	X	X	X	X	X	X							X	X	
Sporobolus wrightii 'Windbreaker'	Windbreaker Giant Sacaton				X	X	X	X	X	X	X	X	X	X							X	X	

Plant Select, 2018; Conservation Garden Park, 2018; Charter Township of Canton, 2006; USDA-Natural Resources Conservation Service, 2000; Missouri Botanical Garden, 2018;

Plants For A Future, 2018; Monrovia, 2018; Growing Green Guide, 2018; Central Coast Low Impact Development Initiative; San Francisco Water Power Sewer, 2016

Plants	Zones													Best Management Practices (BMPs)								
	3b	4a	4b	5a	5b	6a	6b	7a	7b	8a	8b	9a	9b	Basin Bottom	Basin Edge	Basin Upland	Swales	Strips	Bioretention Cells/Rain Gardens	Tree Box Filters	Green Roofs	
Perennials																						
<i>Sedum spurium</i> 'Bronze Carpet'	x	x	x	x	x	x	x	x	x	x	x	x	x									x
<i>Sedum spurium</i> 'Schorbuser Blut'	x	x	x	x	x	x	x	x	x	x	x	x	x									x
<i>Sedum rupestre</i> 'Variegated'	x	x	x	x	x	x	x	x	x	x	x	x	x									x
<i>Sedum x cremnosedum</i> 'Little Gem'										x	x	x	x									x
<i>Sidalcea</i> 'Party Girl'				x	x	x	x	x	x						x	x		x				
<i>Silphium perfoliatum</i>	x	x	x	x	x	x	x	x	x	x	x	x	x			x						
<i>Sisyrinchium</i> 'Devon Skies'								x	x	x	x	x	x									x
<i>Sisyrinchium angustifolium</i> 'Lucerne'				x	x	x	x	x	x	x	x	x	x									x
<i>Solidago rugosa</i> 'Fireworks'		x	x	x	x	x	x	x	x	x	x	x	x			x						
<i>Stachys byzantina</i> 'Helen von Stein'		x	x	x	x	x	x	x	x	x	x				x	x		x				
<i>Stachys byzantina</i> 'Primrose Heron'		x	x	x	x	x	x	x	x	x	x				x	x		x				
<i>Symphotrichum novae-angliae</i>		x	x	x	x	x	x	x	x	x	x					x						
<i>Symphotrichum puniceum</i>	x	x	x	x	x	x	x	x	x	x	x	x	x			x						
<i>Thymus argenteus</i> 'Hi Ho Silver'				x	x	x	x	x	x	x	x	x	x									x
<i>Thymus pseudolanuginosus</i>				x	x	x	x	x	x	x	x				x	x		x				x
<i>Thymus serpyllum</i>					x	x	x	x	x	x	x	x	x									x
<i>Thymus serpyllum</i> 'Elfin'					x	x	x	x	x	x	x	x	x									x
<i>Thymus serpyllum</i> 'Pink Chintz'				x	x	x	x	x	x	x	x	x	x									x
<i>Thymus vulgaris</i>				x	x	x	x	x	x	x	x	x	x									x
<i>Typha latifolia</i>	x	x	x	x	x	x	x	x	x	x	x	x	x	x			x		x			
<i>Verbena hastata</i>	x	x	x	x	x	x	x	x	x	x	x			x	x	x	x	x	x	x		
<i>Vernonia fasciculata</i>		x	x	x	x	x	x	x	x	x	x	x			x	x						
<i>Zizia aurea</i>	x	x	x	x	x	x	x	x	x	x	x					x						

Plant Select, 2018; Conservation Garden Park, 2018; Charter Township of Canton, 2006; USDA-Natural Resources Conservation Service, 2000; Missouri Botanical Garden, 2018;

Plants For A Future, 2018; Monrovia, 2018; Growing Green Guide, 2018; Central Coast Low Impact Development Initiative; San Francisco Water Power Sewer, 2016

Plants	Zones													Best Management Practices (BMPs)							
	3b	4a	4b	5a	5b	6a	6b	7a	7b	8a	8b	9a	9b	Basin Bottom	Basin Edge	Basin Upland	Swales	Strips	Bioretenti on Cells/ Rain Gardens	Tree Box Filters	Green Roofs
Groundcovers																					
Ajuga x 'Toffe Chip' Plant Patent # 18,805	Toffe Chip Carpet Bugle																				
Campanula 'Samantha'				x	x	x	x	x	x	x	x	x	x								
Diachondra repens									x	x	x	x	x	x	x				x	x	x
Delosperma 'Strong Red'									x	x	x	x	x								x
Delosperma cooperi 'Jewel of Desert Garnet' Plant Patent #23, 471				x	x	x	x	x	x	x	x	x	x								x
Delosperma cooperi 'Jewel of Desert Moonstone' Plant Patent #23, 49				x	x	x	x	x	x	x	x	x	x								x
Juniperus horizontalis 'Bar Harbor'	x	x	x	x	x	x	x	x	x	x	x	x	x						x		x
Juniperus horizontalis 'Hughes'	x	x	x		x	x	x	x	x	x	x	x	x						x		x
Juniperus horizontalis 'Plumosa Compacta'	x	x	x	x	x	x	x	x	x	x	x	x	x								x
Juniperus horizontalis 'Prince of Wales'	x	x	x	x	x	x	x	x	x	x	x	x	x								x
Juniperus horizontalis 'Youngstown'	x	x	x	x	x	x	x	x	x	x	x	x	x								x
Juniperus sabina 'Buffalo'	x	x	x	x	x	x	x	x	x	x	x	x	x								x
Juniperus sabina 'Skandia'	x	x	x	x	x	x	x	x	x	x	x	x	x								x
Nepeta racemosa 'Walker's Low'		x	x	x	x	x	x	x	x	x	x	x	x						x	x	
Nepeta sibirica 'Souvenir d' Andre Chaudron'	x	x	x	x	x	x	x	x	x	x	x	x	x						x	x	x
Nepeta x faassenii 'Select Blue'		x	x	x	x	x	x	x	x	x	x	x	x						x	x	
Nepeta 'Pstike'		x	x	x	x	x	x	x	x	x	x	x	x						x	x	
Teucrium chamaedrys 'Prostratum'				x	x	x	x	x	x	x	x	x	x						x		
Veronica armeria		x	x	x	x	x	x	x	x	x	x	x	x						x		x
Veronica liwanensis	x	x	x	x	x	x	x	x	x	x	x	x	x						x		x
Veronica 'Reavis'	x	x	x	x	x	x	x	x	x										x		
Veronica x 'P0185'	x	x	x	x	x	x	x	x	x	x	x	x	x						x		

Plant Select, 2018; Conservation Garden Park, 2018; Charter Township of Canton, 2006; USDA-Natural Resources Conservation Service, 2000; Missouri Botanical Garden, 2018;

Plants For A Future, 2018; Monrovia, 2018; Growing Green Guide, 2018; Central Coast Low Impact Development Initiative; San Francisco Water Power Sewer, 2016

Plants		Zones													Best Management Practices (BMPs)							
		3b	4a	4b	5a	5b	6a	6b	7a	7b	8a	8b	9a	9b	Basin Bottom	Basin Edge	Basin Upland	Swales	Strips	Bioretenti on Cells/ Rain Gardens	Tree Box Filters	Green Roofs
Vines																						
Aristolochia californica	Pipe Vine									x	x	x	x		x			x				
Campsis radicans f. flava	Yellow Trumpetvine				x	x	x	x	x	x	x	x	x							x		
Clematis ligusticifolia	Western White Clematis				x	x	x	x	x	x	x	x	x	x	x	x	x	x	x	x		
Vitis labrusca 'Concord'	Concord Grape				x	x	x	x	x	x	x	x				x	x	x	x			
Vitis labrusca 'Niagara'	Niagara Grape				x	x	x	x	x	x	x	x				x	x	x	x			
Vitis 'Himrod'	Himrod Grape				x	x	x	x	x	x	x	x				x	x	x	x			
Vitis 'St. Theresa'	St. Theresa Grape				x	x	x	x	x	x	x	x				x	x	x	x			
Vitis x 'St. Theresa Seedless'	St. Theresa seedless grape		x	x	x	x	x	x	x	x	x	x	x			x	x	x	x			

Plant Select, 2018; Conservation Garden Park, 2018; Charter Township of Canton, 2006; USDA-Natural Resources Conservation Service, 2000; Missouri Botanical Garden, 2018;

Plants For A Future, 2018; Monrovia, 2018; Growing Green Guide, 2018; Central Coast Low Impact Development Initiative; San Francisco Water Power Sewer, 2016

Plants	Zones													Best Management Practices (BMPs)								
	3b	4a	4b	5a	5b	6a	6b	7a	7b	8a	8b	9a	9b	Basin Bottom	Basin Edge	Basin Upland	Swales	Strips	Bioretention Cells/ Rain Gardens	Tree Box Filters	Green Roofs	
Cacti & Succulents																						
Aloe 'Carmine'												x	x									x
Aloe 'Donnie'												x	x									x
Aloe 'Guido'												x	x									x
Aloe 'Pink Blush'												x	x									x
Aloe 'Sal'												x	x									x
Asclepias speciosa Torr.				x	x	x	x	x	x	x	x	x	x	x	x		x		x	x		
Echeveria agavoides 'Lipstick'												x	x									x
Echeveria elegans												x	x									x
Echeveria imbricata												x	x									x
Echeveria setosa												x	x									x
Echeveria shaviana												x	x									x
Echeveria 'Black Prince'												x	x									x
Echeveria 'Perle von Nurnberg'												x	x									x
Echeveria 'Ruffles'												x	x									x
Hesperaloe parviflora				x	x	x	x	x	x	x	x	x	x									x
Hesperaloe parviflora 'Perpa'				x	x	x	x	x	x	x	x	x	x									x
Hesperaloe parviflora 'Yellow'				x	x	x	x	x	x	x	x	x	x									x
Sempervivum arachnoideum 'Cebenese'		x	x	x	x	x	x	x	x	x	x	x	x									x
Sempervivum tectorum ssp. greenii		x	x	x	x	x	x	x	x	x	x	x	x									x
Sempervivum 'Jade Rose'		x	x	x	x	x	x	x	x	x	x	x	x									x
Sempervivum 'Royal Ruby'		x	x	x	x	x	x	x	x	x	x	x	x									x
Sempervivum 'Silver King'		x	x	x	x	x	x	x	x	x	x	x	x									x
Yucca filamentosa				x	x	x	x	x	x	x	x	x	x							x		
Yucca filamentosa 'Bright Edge'		x	x	x	x	x	x	x	x	x	x	x	x							x		

Plant Select, 2018; Conservation Garden Park, 2018; Charter Township of Canton, 2006; USDA-Natural Resources Conservation Service, 2000; Missouri Botanical Garden, 2018;

Plants For A Future, 2018; Monrovia, 2018; Growing Green Guide, 2018; Central Coast Low Impact Development Initiative; San Francisco Water Power Sewer, 2016

Appendix F References

- AHBL. (2017, November). Gap Analysis User Guide & Template. Sacramento: CASQA.
- APWA. (2012, October). *Manual of Best Management Practices for Stormwater Quality*. Retrieved from Mid-America Regional Council: <http://www.marc.org/Environment/Water-Resources/Local-Government-Resources/Stormwater-Best-Management-Practices>
- California Department of Transportation Division of Environmental Sciences. (2015). *Runoff Coefficient Evaluation for Volumetric BMP Sizing*. Sacramento.
- California Regional Water Quality Control Board Los Angeles Region. (2016). *NPDES PERMIT NO. CAS004001*. Retrieved July 17, 2018, from https://www.waterboards.ca.gov/losangeles/water_issues/programs/stormwater/municipal/los_angeles_ms4/2016/OrderR4-2012-0175_corrected_120216.pdf
- California Regional Water Quality Control Board San Diego Region. (2015). *NPDES NO. CAS0109266*. Retrieved July 17, 2018, from https://www.waterboards.ca.gov/sandiego/water_issues/programs/stormwater/docs/2015-1118_AmendedOrder_R9-2013-0001_COMPLETE.pdf
- Caltrans Division of Environmental Analysis. (2003). *Roadside Vegetated Treatment Sites (RVTS) Study*.
- Central Coast Low Impact Development Initiative. (n.d.). *LID Plant Guidance for Bioretention*. Retrieved from Toolbox | CASQA - California Stormwater Quality Association.
- Charlesworth, S. M., Beddow, J., & Nnadi, E. O. (2017). *The Fate of Pollutants in Porous Asphalt Pavements, Laboratory Experiments to Investigate Their Potential to Impact Environmental Health*. International Journal of Environmental Research.
- Charter Township of Canton. (2006). *Detention Basin Planting Guidelines*. Canton: Charter Township of Canton Department of Municipal Services.
- Conservation Garden Park*. (2018). (West Jordan Conservation Garden Park) Retrieved August 2018, from <http://conservationgardenpark.org>
- D.B. Booth, C. J. (1997). Urbanization of Aquatic Systems - Degradation Thresholds, Stormwater Detention, and the Limits of Mitigation. *Water Resources Bulletin*, pp. 1077-1090.
- Driscoll, E. (1983). *Rainfall/Runoff Relationships from the NURP Run-off Database*. Montreal, Quebec: Presented at Stormwater and Quality Models Users Group Meeting.
- Dupont, R. R., & McLean, J. (2018). Optimizing Stormwater BMP Performance. Retrieved August 27, 2018, from <https://uwrl.usu.edu/environmental-quality/projects/stormwater>
- Dupont, R. R., McLean, J., Peralta, R., Null, S., & Jackson-Smith, D. (2017). *NCEER Assistance Agreement Annual Progress Report for Grant #83582401 - Assessment of Stormwater Harvesting via Manage Aquifer Recharge (MAR) to Develop New Water Supplies in the Arid West: The Salt Lake Valley Example*. Utah State University.
- Filtterra Bioretention*. (2018). Retrieved August 18, 2018, from <https://www.conteches.com/Stormwater-Management/Biofiltration-Bioretention/Filtterra>
- Growing Green Guide*. (2018). Retrieved August 2018, from Green Roof Plants: <http://www.growinggreenguide.org/technical-guide/design-and-planning/plant-selection/green-roofs/>
- Guo, J. (2013). *Derivation and Calibration of Volume-Based Runoff Coefficients for Denver Metro Area, Colorado*. Denver: Urban Drainage Flood Control District.
- Heiberger, J. R. (2013). *Infiltration and Potential Groundwater Recharge Performance of Stormwater Bioretention Designed for Semiarid Climates*. Dissertation, University of Utah, Department of Civil and Environmental Engineering.
- Kieser & Associates, LLC. (2009). *A Scientifically Defensible Process for the Exchange of Pollutant Credits under Minnesota's Proposed Water Quality Trading Rules*.
- Konrad, C., & Booth, D. (2002). *Hydrologic Trends Associated with Urban Development in Western Washington Streams*. Tacoma: United States Geological Survey Water-Resources Investigations Report 02-4040.
- Mark Grey, D. S. (2013, February 13). *The Costs of LID*. Retrieved July 15, 2018, from <https://foresternetwork.com/daily/water/stormwater-management/the-costs-of-lid/>

- McPherson, E., Simpson, J., Peper, P., Maco, E., & Xiao, Q. (2005). Municipal Forest Benefits and Costs in Five US Cities. *Journal of Forestry*, 411-416.
- Minnesota Pollution Control Agency. (2017, August 24). *Better Site Design*. Retrieved July 21, 2018, from https://stormwater.pca.state.mn.us/index.php/Better_site_design
- Minnesota Pollution Control Agency. (2018, February 12). *Information on Pollutant Removal by BMPs*. Retrieved July 27, 2018, from https://stormwater.pca.state.mn.us/index.php/Information_on_pollutant_removal_by_BMPs
- Missouri Botanical Garden. (2018). Retrieved August 2018, from <http://www.missouribotanicalgarden.org>
- Monrovia. (2018). Retrieved August 2018, from <http://www.monrovia.com>
- Plant Select. (2018). (Denver Botanical Garden, Colorado State University) Retrieved August 2018, from Our Plants: <http://plantselect.org/plants/our-plants/>
- Plants For A Future. (2018). *Plants For A Future*. Retrieved August 2018, from Crataegus arnoldiana PFAF Plant Database: <https://pfaf.org/user/Plant.aspx?LatinName=Crataegus+arnoldiana>
- Reese, A. (2006, July-August). Voodoo Hydrology. *Stormwater - The Journal for Surface Water Quality*.
- San Francisco Water Power Sewer. (2016, May). San Francisco Stormwater Management Requirements and Design Guidelines. San Francisco, California.
- Schueler, T. R. (1987). *Controlling Urban Runoff: A Practical Manual for Planning and Designing Urban BMPs*. Washington, D.C.: Metropolitan Washington Council of Governments.
- Schueler, T. R. (2000). *Irreducible Pollutant Concentrations Discharged from Stormwater Practices: The Practice of Watershed Protection*. Ellicott City: Center for Watershed Protection.
- Stormwater Retrofit Techniques for Restoring Urban Drainages in Massachusetts and New Hampshire: Small MS4 Permit Technical Support Document. (2011, April).
- Taylor, S., & Barrett, M. (2014). *Long-Term Performance and Life-Cycle Costs of Stormwater Best Management Practices*. Washington, D.C.: Transportation Research Board.
- United States Environmental Protection Agency. (2012, March). *Terminology of Low Impact Development*. Retrieved August 28, 2018, from <https://www.epa.gov/sites/production/files/2015-09/documents/bbfs2terms.pdf>
- USDA-Natural Resources Conservation Service. (2000). *Stormwater Plant Materials*. Boise: Boise Public Works.
- Velásquez, R. A. (2018). *Application of WINSLAMM to Evaluate the Effect of Green Infrastructure Implementation in Northern Utah*.
- WEF Press. (2012). *Design of Urban Stormwater Controls*. New York: Water Environment Federation; Environmental and Water Resources Institute of ASCE; McGraw-Hill Professional.
- WERF. (2016). *International Stormwater BMP Database*. Retrieved July 28, 2018, from <http://bmpdatabase.org/Docs/03-SW-1COh%20BMP%20Database%202016%20Summary%20Stats.pdf>
- Yang, B., Li, S., Wall, H. A., Blackmore, P., & Wang, Z. (2015). *Green Infrastructure Design for improving Stormwater Quality: Daybreak community in the United States West*. Retrieved from <https://digitalcommons.usu.edu/roch/10>